

DAIKIN

INSTALLATION MANUAL

R32 Split Series

INVERTER

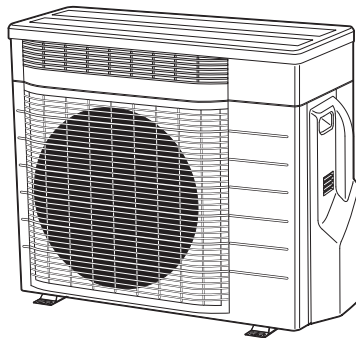
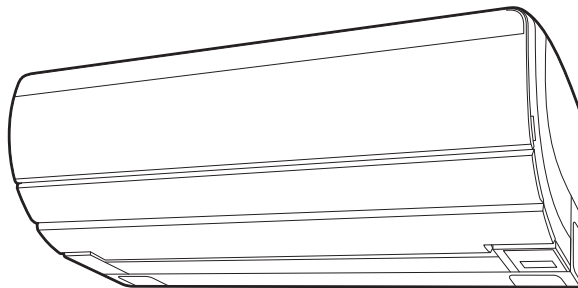

MODELS

FTXZ25NV1B RXZ25NV1B RXZ25NV1B9
FTXZ35NV1B RXZ35NV1B RXZ35NV1B9
FTXZ50NV1B RXZ50NV1B RXZ50NV1B9

Installation manual
R32 Split series

English

Manuel d'installation
Série split R32

Français

Manual de instalación
Serie Split R32

Español

Manuale d'installazione
Serie Multiambienti R32

Italiano

Εγχειρίδιο εγκατάστασης
διαιρούμενης σειράς R32

Ελληνικά

Руководство по монтажу
Серия R32 с отдельной установкой

Русский

Montaj kılavuzları
R32 Split serisi

Türkçe

Contents

Safety Precautions	2	Outdoor Unit Installation	12
Accessories	4	1. Installing outdoor unit	12
Choosing an Installation Site	4	2. Drain work	12
1. Indoor unit	4	3. Flaring the pipe end	12
2. Wireless remote controller (When mounting on a wall etc.)	5	4. Refrigerant piping	13
3. Outdoor unit	5	5. Refrigerant piping work	13
Precautions for humidifying hose installation work	5	6. Evacuating the air with a vacuum pump and checking gas leakage	14
Indoor/Outdoor Unit Installation Drawings	6	7. Wiring	15
Indoor Unit Installation	7	8. Connecting the humidifying hose	16
1. Installing the mounting plate	7	9. Setting the humidifying hose length	16
2. Boring a wall hole and installing wall embedded pipe	7	Installation Tips	17
3. Installing inter-unit wiring	7	Removing and installing the front panel	17
4. Humidifying hose installation work	8	Removing and installing the front grille	17
5. Laying piping, hoses, and wiring	9	How to set the different addresses	18
6. Wiring	10	Connecting to the HA system (Wired remote controller, central remote controller etc.)	18
7. Drain piping	11	Pump down operation	18
8. Improving installation strength	11	Trial Operation and Testing	19
Outdoor Unit Installation Guidelines	12	1. Setting of the position where the indoor unit is installed	19
Precautions on Installation of Outdoor Unit	12	2. Installing the air-purifying and deodorising filter	19
		3. Trial operation and testing	19
		4. Test items	20

Safety Precautions



Read the precautions in this manual carefully before operating the unit.



This appliance is filled with R32.

- The precautions described herein are classified as WARNING and CAUTION. They both contain important information regarding safety. Be sure to observe all precautions without fail.
- Meaning of WARNING and CAUTION notices



WARNING Failure to follow these instructions properly may result in personal injury or loss of life.



CAUTION..... Failure to observe these instructions properly may result in property damage or personal injury, which may be serious depending on the circumstances.

- The safety marks shown in this manual have the following meanings:



Be sure to follow the instructions.





Be sure to establish an earth connection.



Never attempt.

- After completing installation, conduct a trial operation to check for faults and explain to the customer how to operate the air conditioner and take care of it with the aid of the operation manual.

WARNING

- **Ask your dealer or qualified personnel to carry out installation work.**
Do not attempt to install the air conditioner yourself. Improper installation may result in water leakage, electric shocks or fire.
- **Install the air conditioner in accordance with the instructions in this installation manual.**
Improper installation may result in water leakage, electric shocks or fire.
- **Be sure to use only the specified accessories and parts for installation work.**
Failure to use the specified parts may result in the unit falling, water leakage, electric shocks or fire.
- **Install the air conditioner on a foundation strong enough to withstand the weight of the unit.**
A foundation of insufficient strength may result in the equipment falling and causing injury.
- **Electrical work must be performed in accordance with relevant local and national regulations and with instructions in this installation manual. Be sure to use a dedicated power supply circuit only.**
Insufficiency of power circuit capacity and improper workmanship may result in electric shocks or fire.
- **Use a cable of suitable length.**
Do not use tapped wires or an extension lead, as this may cause overheating, electric shocks or fire.
- **Make sure that all wiring is secured, the specified wires are used, and that there is no strain on the terminal connections or wires.**
Improper connections or securing of wires may result in abnormal heat build-up or fire.
- **When wiring the power supply and connecting the wiring between the indoor and outdoor units, position the wires so that the control box lid can be securely fastened.**
Improper positioning of the control box lid may result in electric shocks, fire or over heating terminals.
- **If refrigerant gas leaks during installation, ventilate the area immediately.** 
Toxic gas may be produced if the refrigerant comes into contact with fire.
- **After completing installation, check for refrigerant gas leakage.** 
Toxic gas may be produced if the refrigerant gas leaks into the room and comes into contact with a source of fire, such as a fan heater, stove or cooker.
- **When installing or relocating the air conditioner, be sure to bleed the refrigerant circuit to ensure it is free of air, and use only the specified refrigerant (R32).**
The presence of air or other foreign matter in the refrigerant circuit causes abnormal pressure rise, which may result in equipment damage and even injury.
- **During installation, attach the refrigerant piping securely before running the compressor.**
If the refrigerant pipes are not attached and the stop valve is open when the compressor is run, air will be sucked in, causing abnormal pressure in the refrigeration cycle, which may result in equipment damage and even injury.
- **During pump-down, stop the compressor before removing the refrigerant piping.**
If the compressor is still running and the stop valve is open during pump-down, air will be sucked in when the refrigerant piping is removed, causing abnormal pressure in the refrigeration cycle, which may result in equipment damage and even injury.

Safety Precautions

WARNING

- **Be sure to earth the air conditioner.**
Do not earth the unit to a utility pipe, lightning conductor or telephone earth lead. Imperfect earthing may result in electric shocks. 
 - **Be sure to install an earth leakage circuit breaker.**
Failure to install an earth leakage circuit breaker may result in electric shocks or fire.
 - **Do not use means to accelerate the defrosting process or to clean, other than those recommended by the manufacturer.**
 - **The appliance must be stored in a room without continuously operating ignition sources (for example: open flames, an operating gas appliance or an operating electric heater).**
 - **Do not pierce or burn.**
 - **Be aware that refrigerants may not contain an odour.**
 - **The appliance must be installed, operated and stored in a room with a floor area larger than 1.8m².**
 - **Comply with national gas regulations.**
-

CAUTION

- **Do not install the air conditioner at any place where there is a danger of flammable gas leakage.**
In the event of a gas leakage, build-up of gas near the air conditioner may cause a fire to break out. 
 - **While following the instructions in this installation manual, install drain piping to ensure proper drainage and insulate piping to prevent condensation.**
Improper drain piping may result in indoor water leakage and property damage.
 - **Tighten the flare nut according to the specified method such as with a torque wrench.**
If the flare nut is too tight, it may crack after prolonged use, causing refrigerant leakage.
 - **Take adequate steps to prevent the outdoor unit being used as a shelter by small animals.**
Small animals making contact with electrical parts can cause malfunctions, smoke or fire. Please instruct the customer to keep the area around the unit clean.
 - **The temperature of refrigerant circuit will be high, please keep the inter-unit wire away from copper pipes that are not thermally insulated.**
 - **Only qualified personnel can handle, fill, purge and dispose of the refrigerant.**
-

N002

■ Important information regarding the refrigerant used

This product contains fluorinated greenhouse gases covered by the Kyoto Protocol. Do not vent gases into the atmosphere.

Refrigerant type: **R32**

GWP⁽¹⁾ value: **550 ***







⁽¹⁾GWP = global warming potential

The refrigerant quantity is indicated on the unit name plate.

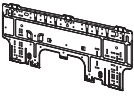



* This value is based on F gas regulation (842/2006).

Accessories

Indoor unit

(A) Mounting plate 	1	(B) Air-purifying and deodorising filter 	1	(C) Indoor unit fixing screws (M4 x 12L) 	3
(D) Wireless remote controller 	1	(E) Remote controller holder 	1	(F) Dry batteries AA.LR6 (alkaline) 	2

Outdoor unit

(G) Humidifying hose (8m) 	1	(H) Drain socket 	1	(J) Joint 	1
(K) Binding bands 	3	(L) Operation manual 	1	(M) Installation manual 	1

- The standard humidifying hose is 8m.
- The extension hose (option) is 2m (KPMH974A402).
- An humidifying hose of 10m (KPMH974A42) is also available as an option to replace the standard one (8m).

Choosing an Installation Site

Before choosing the installation site, obtain user approval.

1. Indoor unit

- The indoor unit should be sited in a place where:
 - 1) the restrictions on installation specified in "Indoor/Outdoor Unit Installation Drawings" on page 6 are met,
 - 2) both air inlet and outlet are free of obstructions,
 - 3) the unit is not in the path of direct sunlight,
 - 4) the unit is away from the source of heat or steam,
 - 5) there is no source of machine oil vapour (this may shorten indoor unit life),
 - 6) cool/warm air is circulated throughout the room,
 - 7) the unit is away from electronic ignition type fluorescent lamps (inverter or rapid start type) as they may shorten the remote control range,
 - 8) the unit is at least 1m away from any television or radio set (unit may cause interference with the picture or sound),
 - 9) space allows for the moving range of the flap in operation above curtain rails or other objects,
 - If (**) is 70mm or more, allow for 15mm of space from the indoor unit.
 - If it is less than 15mm, this can affect the opening and closing of the shutter (bottom air inlet).
 - 10) a height of 2.5m or more is allowed for installation,
 - 11) no laundry equipment is located nearby.

Including the mounting plate *

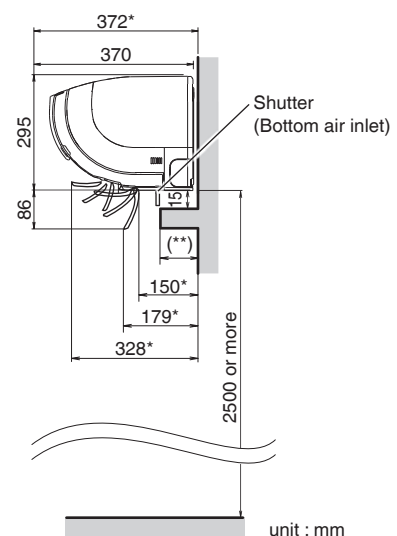

Choosing an Installation Site

2. Wireless remote controller (When mounting on a wall etc.)

- Turn on all the fluorescent lamps in the room, if any, and find the site where remote control signals are properly received by the indoor unit (within 7m).
- Select a place where the remote controller is not hit by direct sunlight. (Selecting a place where direct sunlight hits the remote controller makes it difficult for the remote controller to receive the signal from the indoor unit.)

3. Outdoor unit

- The outdoor unit should be sited in a place where:
 - 1) the restrictions on installation specified in “**Indoor/Outdoor Unit Installation Drawings**” on page 6 are met,
 - 2) the ground is solid enough to bear the weight and vibration of the unit and where the operating sound will not be amplified,
 - 3) the hot air discharged from the unit or the operating sound will not cause a nuisance to the neighbors of the user,
 - 4) there is no bedroom or the like nearby, so that the operating sound will cause no trouble,
 - 5) there are sufficient spaces for carrying the unit into and out of the site,
 - 6) both air inlet and outlet have clear paths of air (they should be free of snow in snowy districts),
 - 7) there is no fear of inflammable gas leakage in a nearby place,
 - 8) units, power cords and inter-unit wires at least 3m away from television and radio sets (This is to prevent interference to images and sounds. Noises may be heard even if they are more than 3m away depending on radio wave conditions),
 - 9) the unit is not directly exposed to salt, sulfidized gases, or machine oil vapour (they may shorten outdoor unit life),
 - 10) nothing which must be kept away from moisture is under the unit since drain flows out of the outdoor unit,
 - 11) the air is clean, and there are no sources of unpleasant odours close by.

NOTE

Cannot be installed hanging from ceiling or stacked.

⚠ CAUTION

When operating the air conditioner in a low outdoor ambient temperature, be sure to follow the instructions described below.

- To prevent exposure to wind, install the outdoor unit with its suction side facing the wall.
- Never install the outdoor unit at a site where the suction side may be exposed directly to wind.
- To prevent exposure to wind, it is recommended to install a baffle plate on the air discharge side of the outdoor unit.
- In heavy snowfall areas, select an installation site where the snow will not affect the unit.

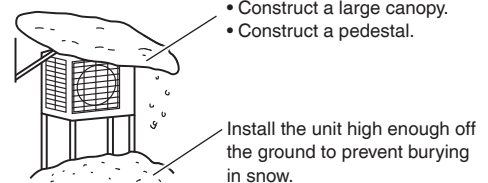

Precautions for humidifying hose installation work

- When embedding ㊸ humidifying hose:
Cannot be installed to the existing embedded piping. Embedding work is separately necessary.
- The length of the ㊸ humidifying hose is marked on the hose packing material.
 - 1) Use an extension hose (option) when extending the ㊸ humidifying hose.
 - 2) The length of the ㊸ humidifying hose needs to be set to ensure humidifying capacity. Cut off any excess hose.
Use the remote controller to set the hose length. (Refer to “**9. Setting the humidifying hose length**” on page 16.)
- If the ㊸ humidifying hose needs to be cut to be laid, cut it, lay it, and connect it using the ㊹ joint included with the outdoor unit or an elbow (field supply). When doing this, wrap it to prevent air leaks with the ㊺ binding band included with the outdoor unit. (Refer to “**4-2 Connecting the cut humidifying hoses**” on page 8.)
- When laying the ㊸ humidifying hose inside the wall, block the ends of the ㊸ humidifying hose with tape or the like to prevent water or anything else from entering it until it is connected to the indoor unit and outdoor unit ducts.

Indoor/Outdoor Unit Installation Drawings

How to attach the indoor unit

- Using the Δ marks (3 locations) on top of the indoor unit, attach the (A) mounting plate hooks onto the indoor unit.
- Attach the tabs on the bottom frame onto the (A) mounting plate. If the tabs are not hooked onto the plate, remove the front grille to hook them. (Check to see if the tabs are hooked securely.)

How to remove the indoor unit

Push up the mark part on the bottom of the front grille (bottom), discharge the tabs, and then remove the unit while lifting it up.

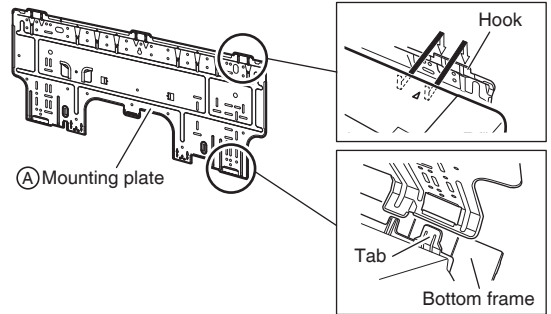
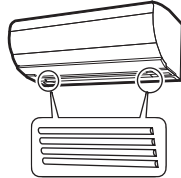

Max. allowable piping length	10m
Min. allowable piping length *	1.5m
Max. allowable piping height	8m
Gas pipe	O.D. 9.5mm
Liquid pipe	O.D. 6.4mm
Max. allowable refrigerant charge amount **	1.34kg

Refrigerant piping must be kept to a minimum.

* The suggested shortest piping length is 1.5m, in order to avoid noise from the outdoor unit and vibration. (Mechanical noise and vibration may occur depending on how the unit is installed and the environment in which it is used.)

** Do not additionally charge refrigerant.

50mm or more from walls (on both sides)

- If the wall on one side is sufficiently away, the distance from the other wall can be 20mm at the minimum.

Install the hose with a downward slope.

Do not bend the (G) humidifying hose more than 90°.

Cut thermal insulation pipe to an appropriate length and wrap it with tape, making sure that no gap is left in the insulation pipe's cut line.

Refrigerant piping must be protected from physical damage. Install a plastic cover or equivalent.

Allow 300mm of work space below the ceiling surface.

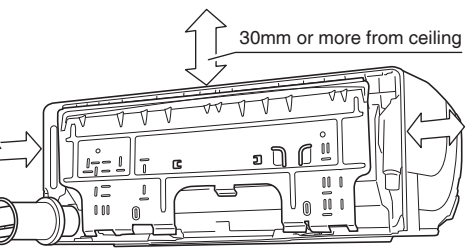

Do not install the trap to the (G) humidifying hose as much as possible.

The flare connection should be installed outdoors.

(G) Humidifying hose

If it is difficult to lay the (G) humidifying hose, cut it, lay it, and connect it using the (J) joint included with the outdoor unit or an elbow (field supply).

CAUTION
* Set the piping length from 1.5m to 10m.

Wrap the insulation pipe with the finishing tape from bottom to top.

250mm from wall

Allow space for piping and electrical servicing.

Connect the flare from the indoor unit side.

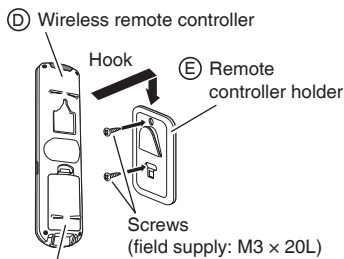

Set the (F) batteries.

Before screwing the (E) remote controller holder to the wall, make sure that control signals are properly received by indoor unit.

In sites with poor drainage, use block bases for outdoor unit. Adjust foot height until the unit is leveled. Otherwise, water leakage or pooling of water may occur.

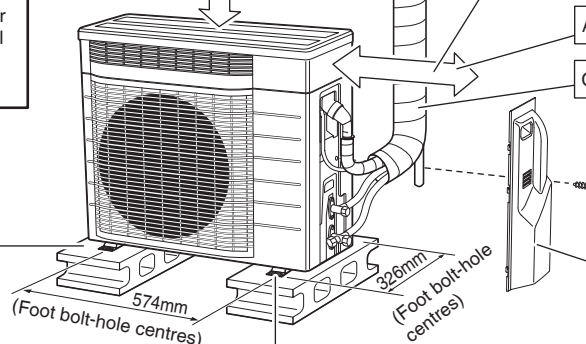

Where there is a danger of the unit falling, use foot bolts, or wires.

Stop valve cover

- How to remove the stop valve cover.**
 - Remove the screw on the stop valve cover.
 - Slide the cover downward to remove it.
- How to attach the stop valve cover.**
 - Insert the upper part of the stop valve cover into the outdoor unit.
 - Tighten the screws.

Indoor Unit Installation

1. Installing the mounting plate

- The (A) mounting plate is located at the back of the indoor unit. Remove a screw.
- The (A) mounting plate should be installed on a wall which can support the weight of the indoor unit.
 - 1) Temporarily secure the (A) mounting plate to the wall, make sure that the plate is completely level, and mark the boring points on the wall.
 - 2) Secure the (A) mounting plate to the wall with screws.

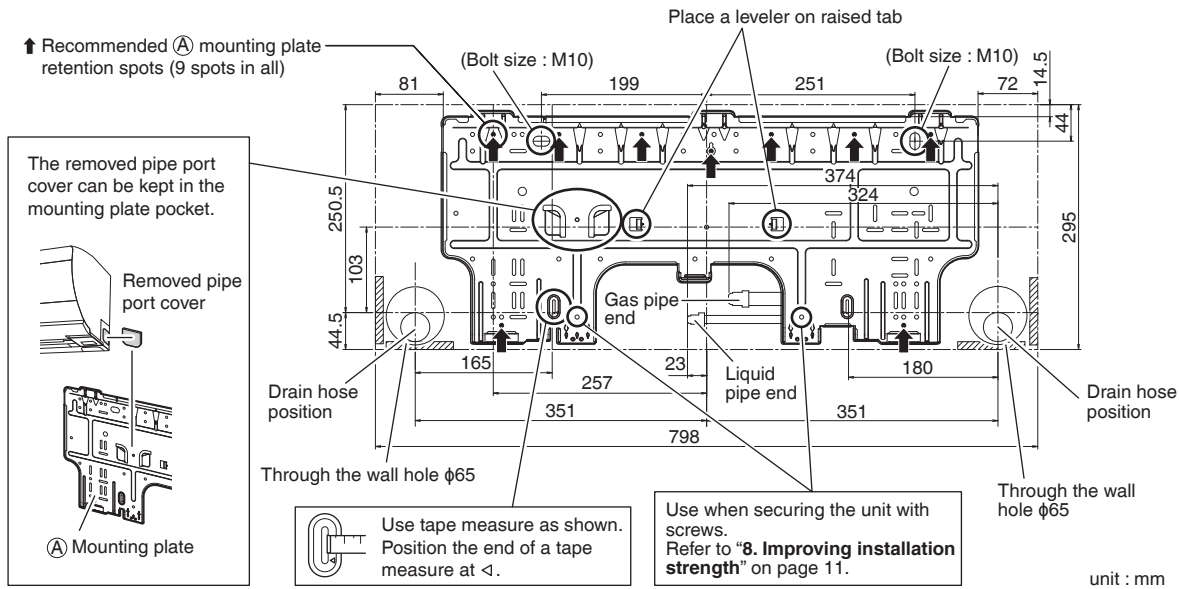

2. Boring a wall hole and installing wall embedded pipe

- For walls containing metal frame or metal board, be sure to use a wall embedded pipe and wall hole cover in the feed-through hole to prevent possible heat, electrical shock, or fire.
- Be sure to caulk the gaps around the pipes with caulking material to prevent water leakage.
 - 1) Bore a feed-through hole of 65mm in the wall so it has a down slope toward the outside.
 - 2) Insert a wall embedded pipe into the hole.
 - 3) Insert a wall hole cover into wall pipe.
 - 4) After completing refrigerant piping, wiring, and drain piping, caulk pipe hole gap with putty.

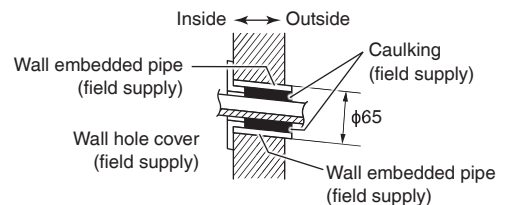

3. Installing inter-unit wiring

- 1) Remove the screw cover and then the service lid.
- 2) Pull out the inter-unit wire from the back of the indoor unit to the front. It is easier to pull out if bending up the wire edge in advance.
- 3) To connect the inter-unit wire after hooking the unit onto the (A) mounting plate, connect the inter-unit wire as shown in the figure.

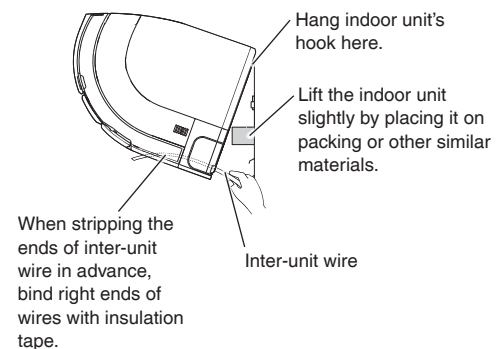
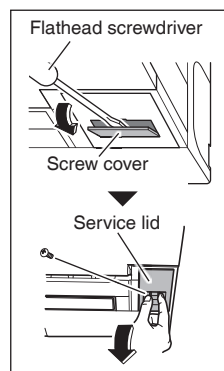

4. Humidifying hose installation work

4-1 Connecting to the indoor unit

- Connect the cuff side of the ⑥ humidifying hose to the indoor unit duct.

It is easier to connect the hose with the front grille removed.

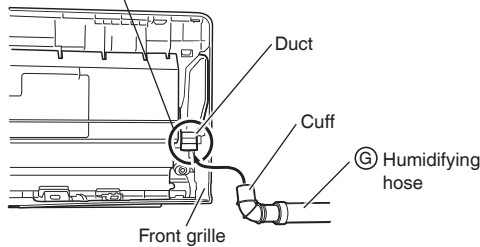

• Left-side piping

Insert as far as possible so that there are no gaps.

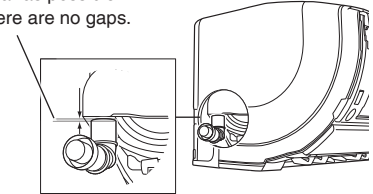

To pull out the ⑥ humidifying hose to the right side, turn the cuff 180° from the position shown in the above illustration.

• Left-bottom piping

Cut the cuff at this point.

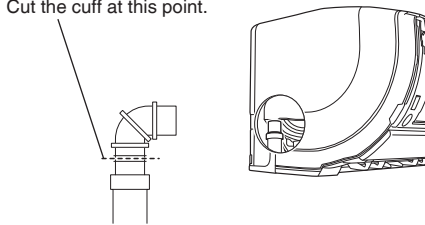

• Left-back piping

Cut the skirt section of the cuff with scissors (cut the dotted line section).

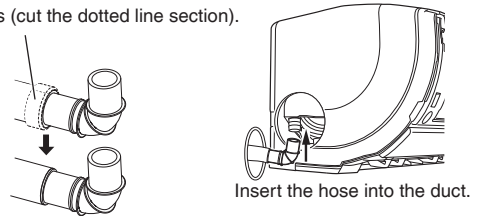

4-2 Connecting the cut humidifying hoses

- When installing the cut ⑥ humidifying hoses, follow the instructions below.

Insert each ⑥ humidifying hose to the rim of the ① joint or an elbow (field supply) so that there are no gaps.



Apply the ④ binding bands at 10mm from the rim of the ① joint or an elbow (field supply) to prevent the ⑥ humidifying hose from coming off.

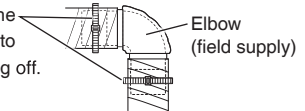

- Use not more than 1 elbow to ensure humidifying capacity.

4-3 How to replace the drain plug and drain hose

• Replacing onto the left side

- Remove the insulation fixing screw on the right to remove the drain hose.
- Reattach the insulation fixing screw on the right as it was. Forgetting to attach this may cause water leakages.
- Remove the drain plug on the left side and attach it to the right side.
- Insert the drain hose and tighten with included ③ indoor unit fixing screw.

How to set drain plug

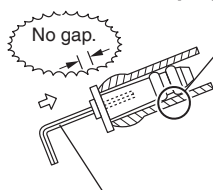

Do not apply lubricating oil (refrigerant oil) to the drain plug when inserting it. The application of lubrication oil to the drain plug will deteriorate the plug to cause drain leakage from the plug.

Insert a hexagon wrench (4mm).

Drain hose attachment position

The drain hose is on the back of the unit.

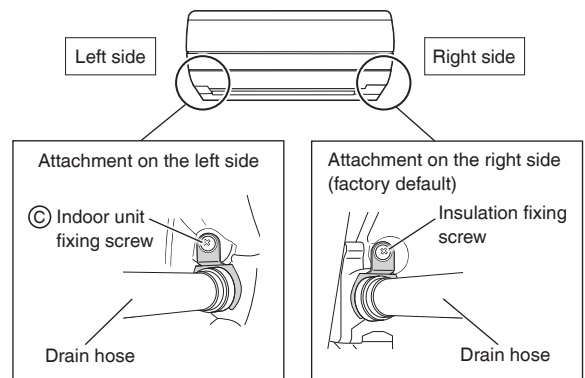

! CAUTION

Use caution not to deform the cuff while installing the humidifying hose. Using a deformed cuff may cause a clogging sound.

Indoor Unit Installation

5. Laying piping, hoses, and wiring

- Lay the pipes, drain hose and ㉔ humidifying hose according to the orientation of the piping coming out of the unit, as shown in the figure.
- Make sure the drain hose is sloped downward.
- Wrap the pipes, drain hose and ㉔ humidifying hose together using insulation tape.

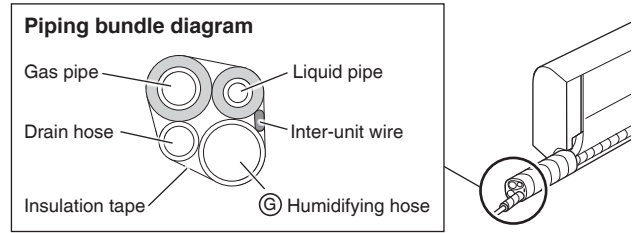

5-1 Right-side, right-back, or right-bottom piping

• Right-side piping

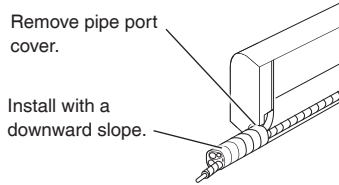

• Right-back piping

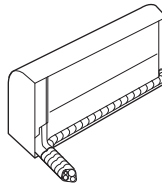

• Right-bottom piping

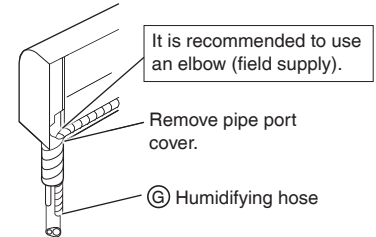

- 1) Wrap the pipes, hose and inter-unit wire using insulation tape as shown in the piping bundle diagram.
- 2) Put all the pipes through the through-hole in the wall and hook the indoor unit onto the ㉑ mounting plate.
- 3) Connect the pipes.

5-2 Left-side, left-back, or left-bottom piping

• Left-side piping

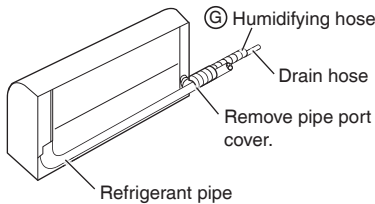

• Left-back piping

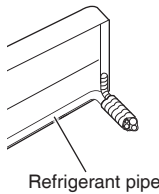

• Left-bottom piping

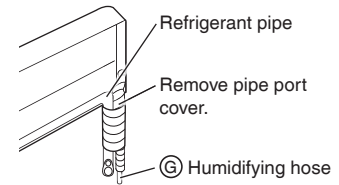

- 1) Replace the drain plug and drain hose. (Refer to “4-3 How to replace the drain plug and drain hose” on page 8.)
- 2) Pull in the refrigerant pipes and lay them so that it matches the liquid and gas piping marked on the ㉑ mounting plate.
- 3) Hook the indoor unit onto the ㉑ mounting plate.
- 4) Connect the pipes. If it is difficult to do, remove the front panel first.
- 5) Wrap the insulation on the pipes with insulation tape. If you are not replacing the drain hose, store it in the location shown below.

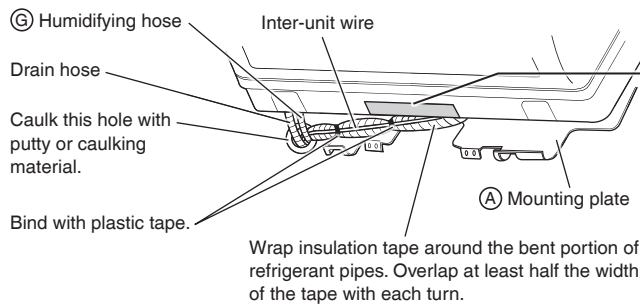

If installation is difficult, remove the pipe cover (4 tabs) and cut off the front grille (bottom).

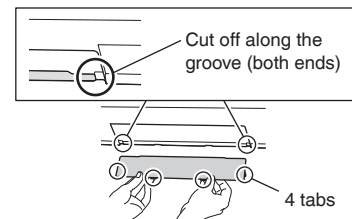

5-3 Wall embedded piping

Follow the instructions given under left-side, left-back, or left-bottom piping.

- 1) Insert the drain hose to this depth so it won't be pulled out of the drain pipe.

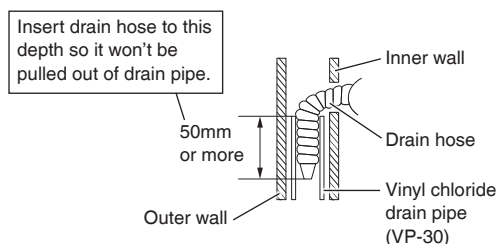

CAUTION

The indoor unit is large, so please be careful not to lose your balance when lifting it.

6. Wiring

- 1) Strip wire ends (15mm).
- 2) Match wire colours with terminal numbers on indoor and outdoor unit's terminal blocks and firmly screw wires to the corresponding terminals.
- 3) Connect the earth wires to the corresponding terminals.
- 4) Pull wires to make sure that they are securely latched up, then retain wires with wire retainer.
- 5) In case of connecting to the HA system. Run the HA connection cord and attach the S21.
(Refer to "Connecting to the HA system" on page 18.)
- 6) Shape the wires so that the service lid fits securely, then close the service lid.

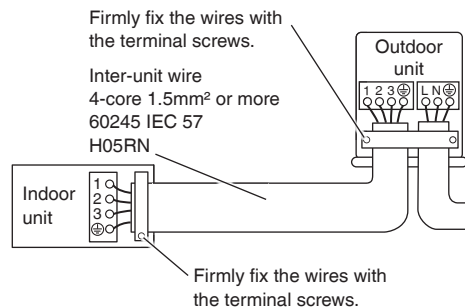
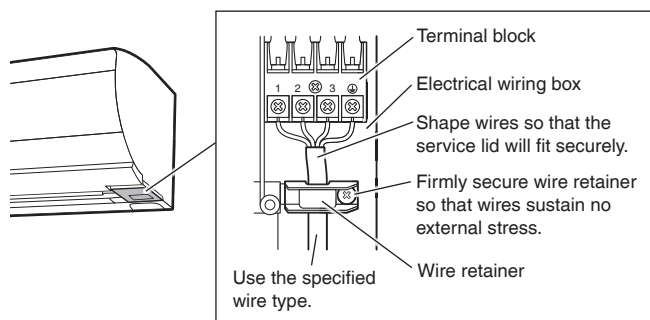

WARNING

- Do not use tapped wires, extension cords, or starburst connections, as they may cause overheating, electrical shock, or fire.
- Do not use locally purchased electrical parts inside the product. (Do not branch the power for the drain pump, etc., from the terminal block.) Doing so may cause electric shock or fire.
- Do not connect the power wire to the indoor unit. Doing so may cause electric shock or fire.

Indoor Unit Installation

7. Drain piping

- 1) Connect the drain hose, as described right.

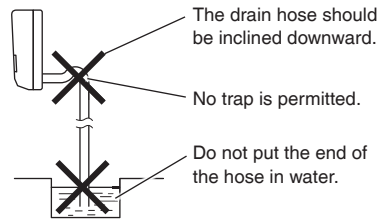

- 2) Remove the air filters and pour some water into the drain pan to check the water flows smoothly.

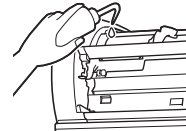

- 3) If drain hose extension or embedded drain piping is required, use appropriate parts that match the hose front end.

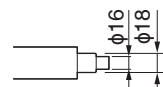
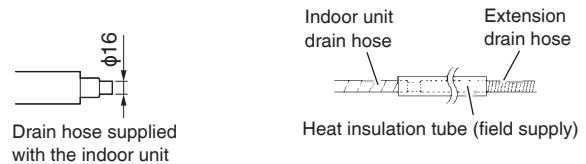
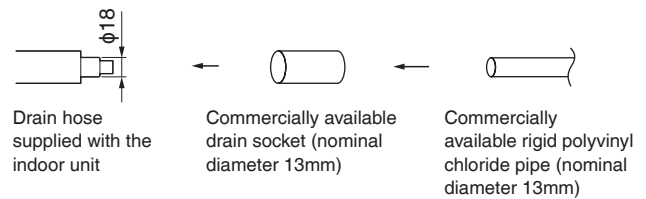

Figure of hose front end

- 4) When drain hose requires extension, obtain an extension hose with an inner diameter of 16mm. Be sure to thermally insulate the indoor section of the extension hose.



- 5) When connecting a rigid polyvinyl chloride pipe (nominal diameter 13mm) directly to the drain hose attached to the indoor unit as with embedded piping work, use any commercially available drain socket (nominal diameter 13mm) as a joint.



8. Improving installation strength

- We recommend screwing the indoor unit onto a (A) mounting plate in order to improve the installation strength.

- 1) Remove the pipe cover of the front grille (bottom). (4 tabs)
- 2) Secure the indoor unit with the (C) indoor unit fixing screws.
- 3) Attach the pipe cover.

Lift up the lower side of the indoor unit and remove the pipe cover.

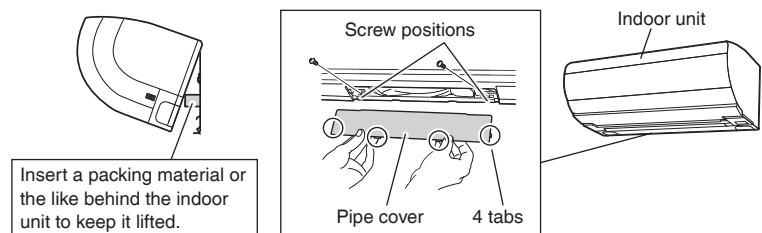

Outdoor Unit Installation Guidelines

- Where a wall or other obstacle is in the path of outdoor unit's intake or exhaust airflow, follow the installation guidelines below.
- For any of the below installation patterns, the wall height on the outlet side should be 1200mm or less.

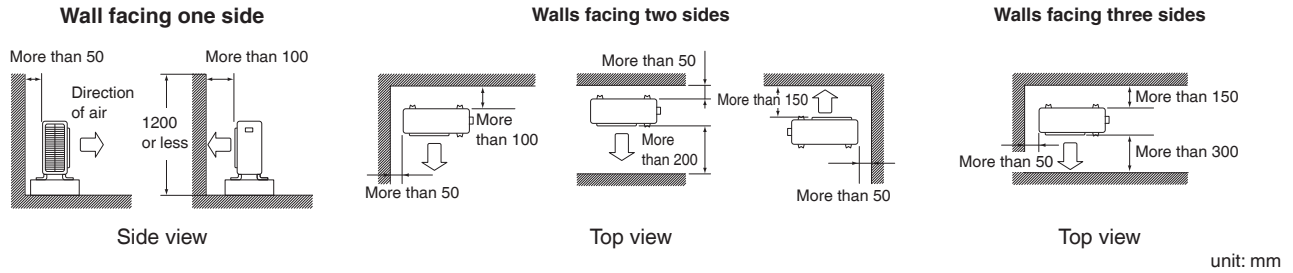

Precautions on Installation of Outdoor Unit

- Check the strength and level of the installation surface so that the unit does not cause any operating vibration or noise after installation.
- In accordance with the foundation drawing, fix the unit securely by means of the foundation bolts. (Prepare 4 sets of M8 or M10 foundation bolts, nuts and washers each which are available on the market.)
- It is best to screw in the foundation bolts until their ends are 20mm from the foundation surface.

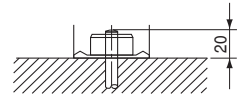

Outdoor Unit Installation

1. Installing outdoor unit

- 1) When installing the outdoor unit, refer to "Choosing an Installation Site" on page 5 and the "Indoor/Outdoor Unit Installation Drawings" on page 6.
- 2) If drain work is necessary, follow the procedures below.

2. Drain work

- 1) Use (H) drain socket for drainage.
- 2) If the drain port is covered by a mounting base or floor surface, place additional foot bases of at least 30mm in height under the outdoor unit's feet.
- 3) In cold areas, do not use a drain hose with the outdoor unit. (Otherwise, drain water may freeze, impairing heating performance.)

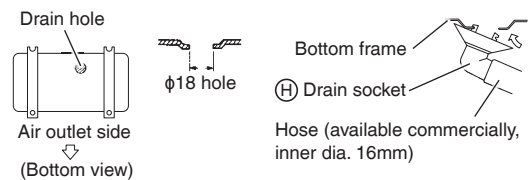

3. Flaring the pipe end

- 1) Cut the pipe end with a pipe cutter.
- 2) Remove burrs with the cut surface facing downward so that the chips do not enter the pipe.
- 3) Put the flare nut on the pipe.
- 4) Flare the pipe.
- 5) Check that the flaring is properly made.

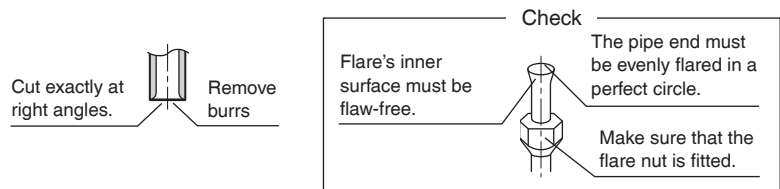

Flaring

Set exactly at the position shown below.

Flare tool for R32 or R410A	Conventional flare tool		
	Clutch-type	Clutch-type (Rigid-type)	Wing-nut type (Imperial-type)
A	0-0.5mm	1.0-1.5mm	1.5-2.0mm



WARNING

- Do not use mineral oil on flared part.
- Prevent mineral oil from getting into the system as this would reduce the lifetime of the units.
- Never use piping which has been used for previous installations. Only use parts which are delivered with the unit.
- Never install a drier to this R32 unit in order to guarantee its lifetime.
- The drying material may dissolve and damage the system.
- Incomplete flaring may cause refrigerant gas leakage.

Outdoor Unit Installation

4. Refrigerant piping

CAUTION

- Use the flare nut fixed to the main unit. (To prevent cracking of the flare nut by aged deterioration.)
 - To prevent gas leakage, apply refrigeration oil only to the inner surface of the flare. (Use refrigeration oil for R32.)
 - Use torque wrenches when tightening the flare nuts to prevent damage to the flare nuts and gas leakage.
-
- Align the centres of both flares and tighten the flare nuts 3 or 4 turns by hand. Then tighten them fully with the torque wrenches.
 - Refrigerant oil for R410A can also be used for application to the inner flare.

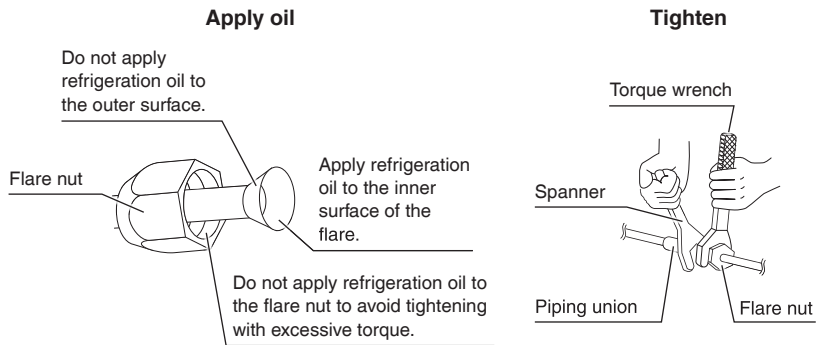

Flare nut tightening torque	
Gas side	Liquid side
9.5mm	6.4mm
32.7-39.9N · m (333-407kgf · cm)	14.2-17.2N · m (144-175kgf · cm)

Valve cap tightening torque	
Gas side	Liquid side
9.5mm	6.4mm
21.6-27.4N · m (220-280kgf · cm)	

Service port cap tightening torque	
10.8-14.7N · m (110-150kgf · cm)	

5. Refrigerant piping work

5-1 Cautions on pipe handling

- Protect the open end of the pipe against dust and moisture.
- All pipe bends should be as gentle as possible. Use a pipe bender for bending.

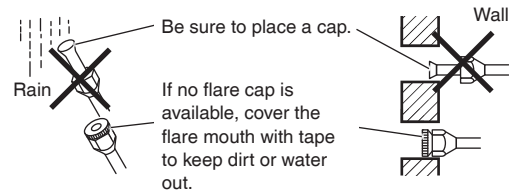

5-2 Selection of copper and heat insulation materials

When using commercial copper pipes and fittings, observe the following:

- Insulation material: Polyethylene foam
Heat transfer rate: 0.041 to 0.052W/mK (0.035 to 0.045kcal/mh°C)
Refrigerant gas pipe's surface temperature reaches 110°C max.
Choose heat insulation materials that will withstand this temperature.
- Be sure to insulate both the gas and liquid piping and to provide insulation dimensions as below.

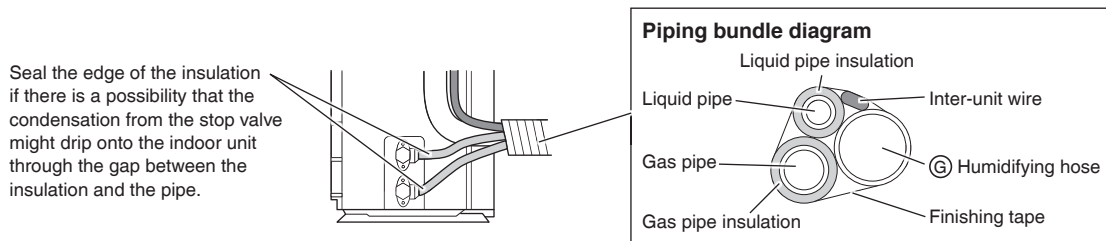

Gas side	Liquid side	Gas pipe thermal insulation	Liquid pipe thermal insulation
O.D. 9.5mm	O.D. 6.4mm	I.D. 12-15mm	I.D. 8-10mm
Minimum bend radius		Thickness 10mm Min.	
30mm or more			
Thickness 0.8mm (C1220T-O)			

- Use separate thermal insulation pipes for gas and liquid refrigerant pipes.

6. Evacuating the air with a vacuum pump and checking gas leakage

WARNING

- Do not mix any substance other than the specified refrigerant (R32) into the refrigeration cycle.
- When refrigerant gas leaks occur, ventilate the room as soon and as much as possible.
- R32, as well as other refrigerants, should always be recovered and never be released directly into the environment.
- **Use tools for R32 or R410A (such as the gauge manifold, charging hose, or vacuum pump adapter).**

- When piping work is completed, it is necessary to evacuate the air with a vacuum pump and check for gas leakage.
- Use a hexagonal wrench (4mm) to operate the stop valve rod.
- All refrigerant pipe joints should be tightened with a torque wrench at the specified tightening torque.

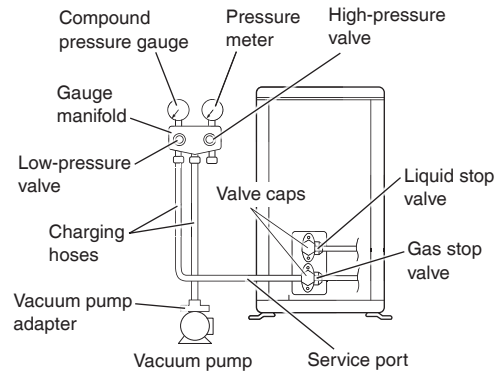

- 1) Connect projection side of charging hose (which comes from gauge manifold) to gas stop valve's service port.
 - 2) Fully open gauge manifold's low-pressure valve (Lo) and completely close its high-pressure valve (Hi).
(High-pressure valve subsequently requires no operation.)
 - 3) Do vacuum pumping and make sure that the compound pressure gauge reads -0.1MPa (-76cmHg).
(The vacuum pump should run for at least 10 minutes.)
 - 4) Close gauge manifold's low-pressure valve (Lo) and stop vacuum pump.
(Keep this state for a few minutes to make sure that the compound pressure gauge pointer does not swing back.)*1
 - 5) Remove covers from liquid stop valve and gas stop valve.
 - 6) Turn the liquid stop valve's rod 90° counterclockwise with a hexagonal wrench to open valve.
Close it after 5 seconds, and check for gas leakage.
Using soapy water, check for gas leakage from indoor unit's flare and outdoor unit's flare and valve rods.
After the check is complete, wipe all soapy water off.
 - 7) Disconnect charging hose from gas stop valve's service port, then fully open liquid and gas stop valves.
(Do not attempt to turn valve rod beyond its stop.)
 - 8) Tighten valve caps and service port caps for the liquid and gas stop valves with a torque wrench at the specified torques.
- *1 If the compound pressure gauge pointer swings back, refrigerant may have water content or a loose pipe joint may exist. Check all pipe joints and retighten nuts as needed, then repeat steps 2) through 4).

Outdoor Unit Installation

7. Wiring

⚠ WARNING

- Do not use tapped wires, extension cords, or starburst connections, as they may cause overheating, electrical shock, or fire.
- Do not use locally purchased electrical parts inside the product. (Do not branch the power for the drain pump, etc., from the terminal block.) Doing so may cause electric shock or fire.
- Be sure to install an earth leak detector. (One that can handle higher harmonics.)
(This unit uses an inverter, which means that an earth leak detector capable of handling harmonics must be used in order to prevent any malfunction of the earth leak detector itself.)
- Use an all-pole disconnection type circuit breaker with at least 3mm between the contact point gaps.
- The earth leakage circuit breaker must operate at 30mA or lower.
- Do not connect the power wire to the indoor unit. Doing so may cause electric shock or fire.

- Do not turn on the circuit breaker until all work is completed.
 - 1) Strip the insulation from the wire (20mm).
 - 2) Connect the inter-unit wires between the indoor and outdoor units **so that the terminal numbers match**. Tighten the terminal screws securely. We recommend a flathead screwdriver be used to tighten the screws. The screws are packed with the terminal block.

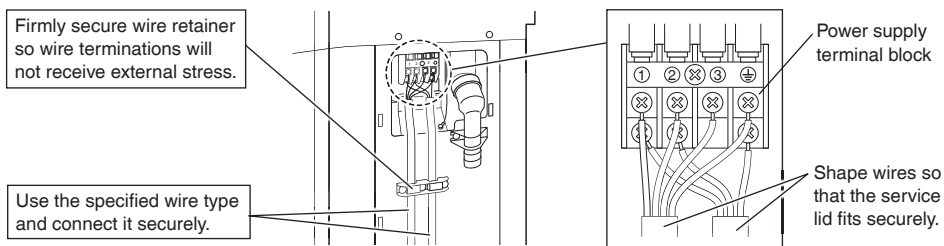
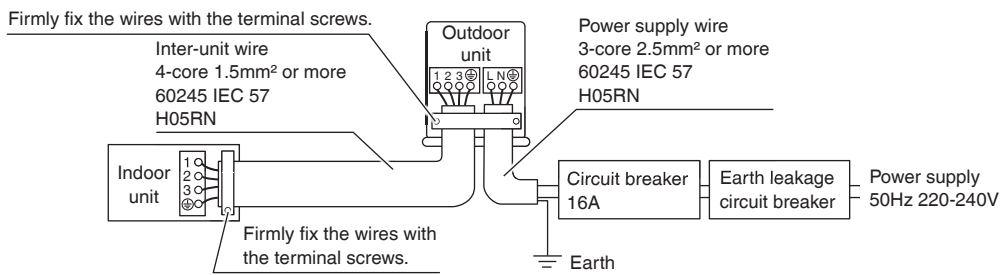

⚠ CAUTION

- When using stranded wires, make sure to use a round crimp-style terminal for connection to the power supply terminal block. Place the round crimp-style terminals on the wires up to the covered part and secure in place.



- Use the following method when installing a round crimp-style terminal.

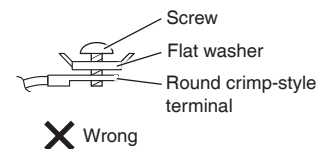
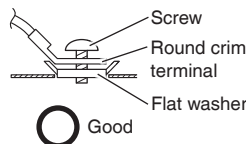
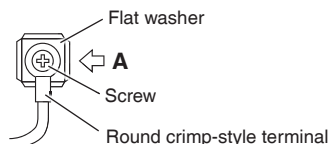

Arrow view A

- Use the following method when installing a single core wire.

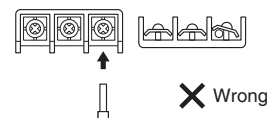
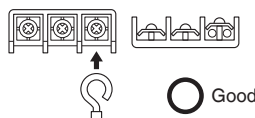

8. Connecting the humidifying hose

- If the air conditioner is operated without the ⑥ humidifying hose connected, humidified air fills the outdoor unit and may cause a short-circuit on the printed circuit board. Be sure to connect it.
 - Connect the ⑥ humidifying hose to the outdoor humidifying duct.
 - Apply a ⑦ binding band to prevent the ⑥ humidifying hose from coming off.

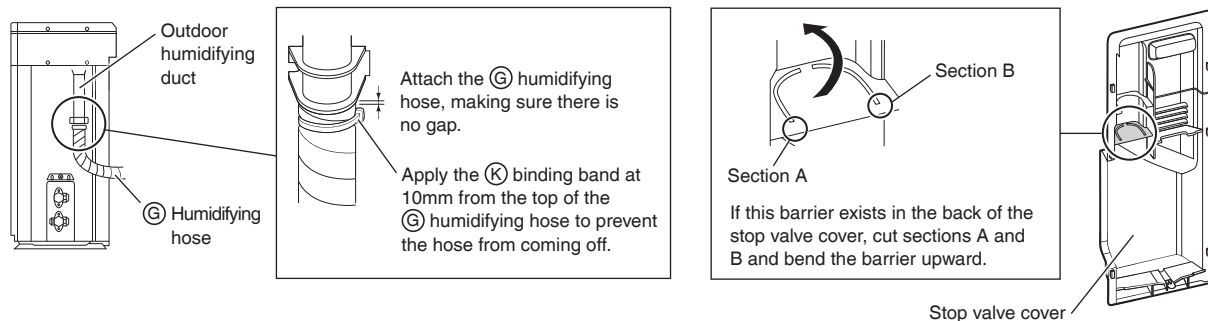

Binding part of binding band

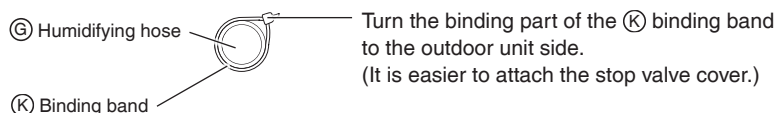

9. Setting the humidifying hose length

- Set the humidifying hose length to ensure humidifying capacity. Use the remote controller to set the humidifying hose length. When doing this, power on the unit as communication is established between the unit and the remote controller.
 - Press **SET UP** for at least 5 seconds.
 - The default menu is displayed.
 - To exit the menu, press **CANCEL** or leave it unoperated for 60 seconds. The display will return to the normal display.
 - Press **▲**. Select **"Hose length"**.
 - Press **APPLY** to enter the humidifying hose length setting mode.
 - Be sure to direct the remote controller toward the indoor unit.
 - The currently set humidifying hose length will be displayed. (No setting is made by default.)
 - Press **▲** and set the humidifying hose length.

The humidifying hose length can be set in 5 stages:

~3M	3.1M~4M	4.1M~6M	6.1M~8M	8.1M~10M
-----	---------	---------	---------	----------
 - When you set the humidifying hose length, press **APPLY**.
 - Direct the remote controller toward the indoor unit.
 - Press **CANCEL**.
 - The setting of the humidifying hose length is complete.
- If you set the humidifying hose length incorrectly, cancel the setting with **"Length Reset"** at step 4), and then set the length again. When the humidifying hose length is already set, only reset is displayed at step 4).
- Incorrectly setting the humidifying hose can cause poor performance and noise. Be sure to set it. (When not set, error code **"UA"** will be displayed.)

< When the unit cannot be powered on >

- When you set the humidifying hose length without powering on the indoor unit. In the above step 3), **"Receive failure"** is displayed. However, with the operations of steps 4) and 5), **"Length set"** is displayed, and the humidifying hose length is saved in the remote controller. The error code **"H"** should be displayed during the operations of steps 4) and 5).
- When you operate the air conditioner, the humidifying hose length will be sent to the indoor unit and the humidifying hose length will be set.

Installation Tips

■ Removing and installing the front panel

• Removal method

- 1) Hook your fingers on both sides of the front panel and open until the panel stops.
Pushing further up from the stopping position allows the panel to be removed more easily.
- 2) While pushing the left side front panel shaft outward, push up the front panel and remove it. (Remove the right side front panel shaft in the same manner.)
- 3) After removing both front panel shafts, pull the front panel toward yourself and remove it.

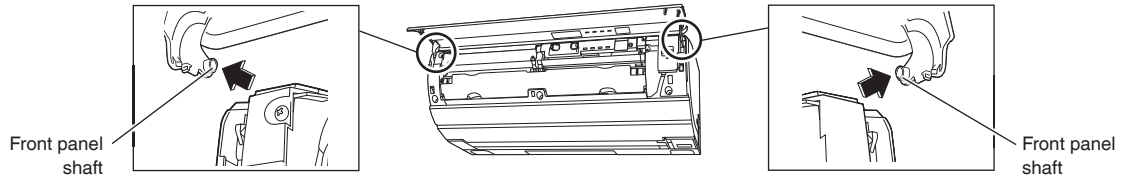

• Installation method

- Insert the right and left front panel shafts on the front panel into the shaft holes one at a time and slowly close the panel.
(Press on both sides of the front panel.)

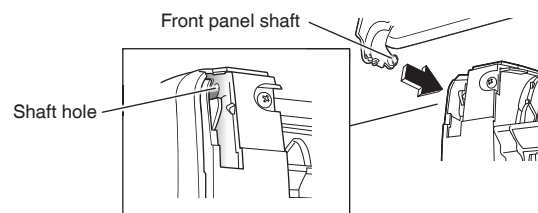

■ Removing and installing the front grille

• Removal method

- 1) Remove the front panel.
- 2) Direct the flap and the auxiliary flap downward.
- 3) Remove the streamer unit. (See Fig. 1)
- 4) Remove the screws that secure the front grille (right). (3 screws) (See Fig. 2)
- 5) While lifting up the front grille (top) with the flathead screwdriver, unhook the tabs and remove the front grille (right). (See Fig. 3)
- 6) Remove the screws that secure the front grille (left). (2 screws) (See Fig. 4)
- 7) While lifting up the front grille (top) with the flathead screwdriver, unhook the tabs and remove the front grille (left).
- 8) Insert the flathead screwdriver and remove the screw cover. (See Fig. 5)
- 9) Remove the screw that secures the service lid and remove the service lid. (See Fig. 6)
- 10) While lifting up the centre part of the front grille (bottom) toward yourself, unhook the 3 tabs. (See Fig. 7)

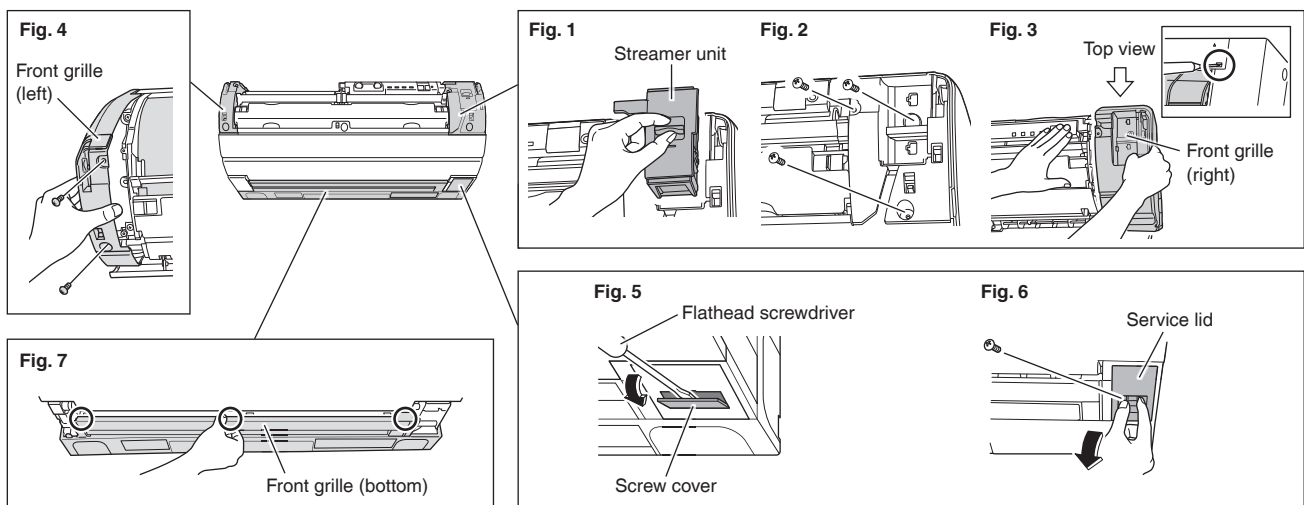

• **Installation method**

- 1) Attach the front grille (bottom).
Make sure that the tabs on both sides are securely hooked. (See Fig. 8)
- 2) Attach the service lid and secure it with a screw.
- 3) Attach the screw cover.
- 4) Attach the front grilles (left and right) and tighten the mounting screws (2 screws for the left side, 3 for the right side).
The front grilles (left and right) are likely to override the front grille (bottom). Pay due caution when attaching them. (See Fig. 9)

Fig. 8

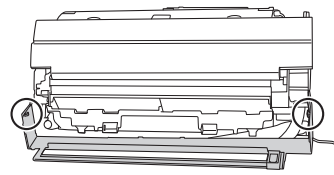
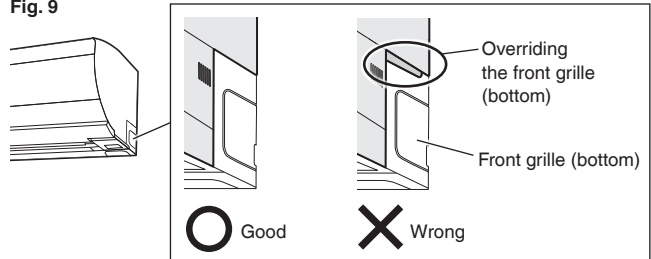

Fig. 9



■ **How to set the different addresses**

- When 2 indoor units are installed in one room, the 2 wireless remote controllers can be set for different addresses. Change the address setting of one of the two units.
- For details, refer to the operation manual.

■ **Connecting to the HA system
(Wired remote controller, central remote controller etc.)**

- 1) Remove the front panel, streamer unit, and front grille (right). (3 screws) (Refer to page 17)
- 2) Remove the electrical wiring box cover. (3 tabs)
- 3) Insert the HA connection cord into the HA connector "S21" (white).
- 4) Route the HA connection cord.
- 5) Reattach the electrical wiring box cover to the original position. (3 tabs)
- 6) Reattach the front grille (right), streamer unit, and front panel to the original positions.

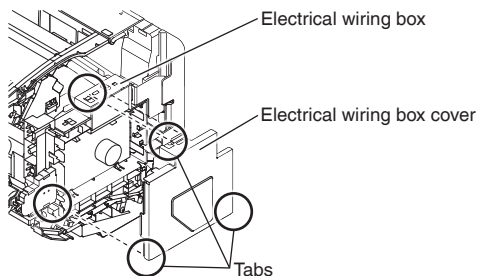

How to route the HA connection cord

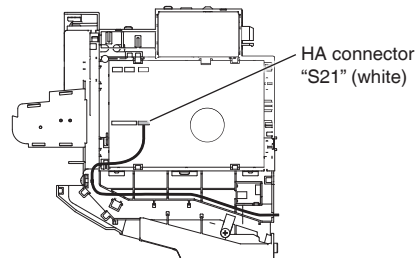

■ **Pump down operation**

In order to protect the environment, be sure to pump down when relocating or disposing of the unit.

- 1) Remove the valve cap from liquid stop valve and gas stop valve.
- 2) Carry out forced cooling operation.
- 3) After 5 to 10 minutes, close the liquid stop valve with a hexagonal wrench.
- 4) After 2 to 3 minutes, close the gas stop valve and stop forced cooling operation.

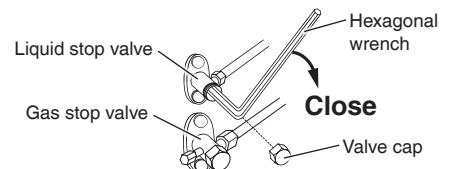

After the operation, reattach the valve cap to the original condition.

< **Forced cooling operation** >

Using the indoor unit ON/OFF switch

Open the front panel and press the indoor unit ON/OFF switch for at least 5 seconds. (The operation will start.)

- Forced cooling operation will stop automatically after about 15 minutes. To stop the operation, press the indoor unit ON/OFF switch.

CAUTION

After closing the liquid stop valve, close the gas stop valve within 3 minutes, then stop the forced cooling operation.

Trial Operation and Testing

1. Setting of the position where the indoor unit is installed

- By setting the room shape and the relation with the installation position, proper airflow direction control can be obtained. If this is not set correctly, proper indoor temperature control may not be provided depending on the airflow settings.

For details, refer to the operation manual.

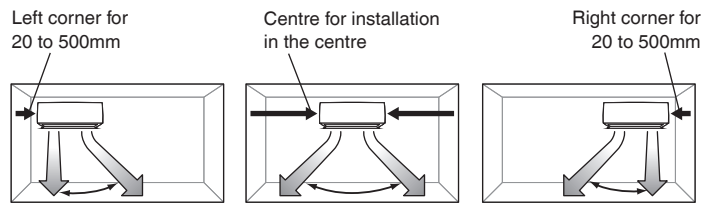

- 1) Press **SET UP**.
- 2) Press **▲** to select "INSTALLED POSITION" and press **APPLY**.
- 3) Select the appropriate item and press **APPLY**.

2. Installing the air-purifying and deodorising filter

- 1) Open the front panel and remove the dust box. Pull down the filter stopper frame (yellow) on the right side.

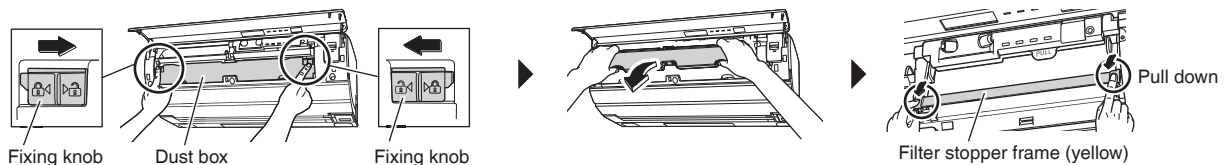

- 2) Direct the display unit (black) upward and remove the air filter.

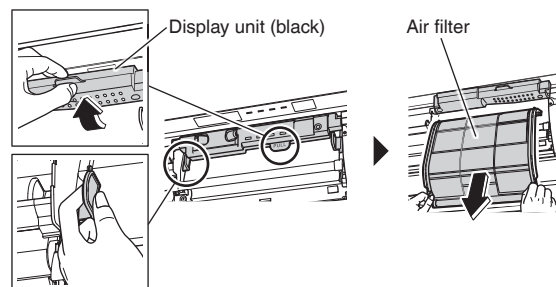

- 3) Install the **Ⓑ** air-purifying and deodorising filter.

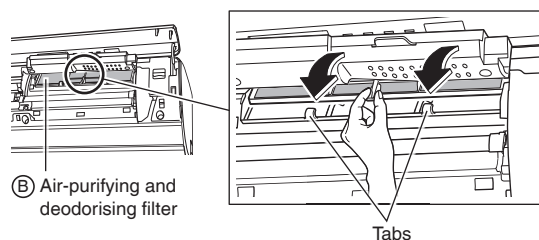

- 4) Restore the air filter and the dust box to the original positions.





3. Trial operation and testing

3-1 Measure the supply voltage and make sure that it falls in the specified range

3-2 Trial operation should be carried out in either COOLING or HEATING operation

- In COOLING operation, select the lowest programmable temperature; in HEATING operation, select the highest programmable temperature.
 - 1) Trial operation may be disabled in either mode depending on the indoor temperature. Use the remote controller for trial operation as described below.
 - 2) After trial operation is complete, set the temperature to a normal level (26°C to 28°C in COOLING operation, 20°C to 22°C in HEATING operation).
 - 3) For protection, the system disables restart operation for 3 minutes after it is turned off.

3-3 To perform a trial operation for humidifying operation, activate trial operation mode from the remote controller following the instructions below and press 





Trial operation from remote controller
1) Press  for at least 5 seconds. (The default menu will be displayed.)
2) Press  to select “Test mode” and press  . <ul style="list-style-type: none"> The unit enters trial operation mode, and  is displayed on the screen.
3) Press the button for the operation mode (COOLING/HEATING/HUMIDIFY) you want to test. <ul style="list-style-type: none"> Trial operation will stop automatically after about 30 minutes. To quit a trial operation, press  .

3-4 Operate the unit in accordance with the operation manual to check that it operates normally

3-5 Make sure that the air conditioner is not in operation before performing CLEANING FILTER operation

- 1) Press  and make sure that CLEANING FILTER operation functions without error.

3-6 After trial operation, reset the total power consumption

- 1) Press  .
- 2) Press  to select “RESET USED POWER” and press  .
- 3) “RESET with APPLY” is displayed. When you press  , the total power consumption is reset.
- Even when the air conditioner is not operating, it consumes some electric power. If the customer is not going to use the unit soon after it is installed, turn off the circuit breaker to avoid wasting electricity.

4. Test items

Test items	Symptom	Check
Indoor and outdoor units are installed properly on solid bases.	Fall, vibration, noise, narrower detectable range of the INTELLIGENT EYE sensor	
Are the air filter and the dust box attached properly?	Noise, water leakage, CLEANING FILTER operation disabled	
Did you install the air-purifying and deodorising filter?	Noise, water leakage, CLEANING FILTER operation disabled	
Have you performed a leak test to ensure that there are no refrigerant gas leaks?	Incomplete cooling/heating function	
Refrigerant gas and liquid pipes and indoor drain hose extension are thermally insulated.	Water leakage	
Draining line is properly installed.	Water leakage	
Did you ask the customer whether drain work for the outdoor unit is necessary?	Dripping of drain water from the hole in the bottom of the outdoor unit	
Does the drain hose produce abnormal noise (clopping sound) when using the ventilation fan or others?	Noise (Use of optional air cut drain plug.)	
System is properly earthed.	Electric shock hazard	
The specified wires are used for inter-unit wiring connections.	Inoperative or burn damage	
Indoor or outdoor unit's air inlet or outlet has clear path of air.	Incomplete cooling/heating function	
Stop valves are opened.	Incomplete cooling/heating function	
Indoor unit properly receives remote controller commands.	Inoperative	
Did you check the address setting?	Inoperative	
Did you set the humidifying hose length?	<ul style="list-style-type: none"> The OPERATION lamp blinks for about 2 minutes from power-on while the air conditioner is stopped. Poor performance and noise 	
Did you set the room shape properly?	Poor cooling performance	

DAIKIN INDUSTRIES, LTD.

Head office:

Umeda Center Bldg., 2-4-12, Nakazaki-Nishi,
Kita-ku, Osaka, 530-8323 Japan

Tokyo office:

JR Shinagawa East Bldg., 2-18-1, Konan,
Minato-ku, Tokyo, 108-0075 Japan
<http://www.daikin.com>

DAIKIN EUROPE N.V.

Zandvoordestraat 300, B-8400 Oostende, Belgium

DAIKIN ISITMA VE SOĞUTMA SİSTEMLERİ SAN.TİC. A.Ş.

Küçükbakkalköy Mah. Kayışdağı Cad. No:1 Kat :21-22 34750 Ataşehir

İSTANBUL / TÜRKİYE

Tel :0216 453 27 00

Faks :0216 671 06 00

Çağrı Merkezi :444 999 0

Web : www.daikin.com.tr



The two-dimensional bar code is
a manufacturing code.

3P338604-1E M12B406D (1903) HT