



DAIKIN ROOM AIR CONDITIONER

OPERATION MANUAL

INVERTER



English

Français

Español

Italiano

Ελληνικά

Русский

Türkçe

MODELS

FTXZ25NV1B

FTXZ35NV1B

FTXZ50NV1B



CONTENTS

Before Operation

Safety precautions	3
Names and functions of parts	5
Preparation before operation	9
◆ To set the batteries ◆ To set the clock	
◆ To set the position where the indoor unit is installed	

Basic Operation

To set operation modes.....	11
◆ AUTO ◆ COOLING ◆ “SARARA” DRY ◆ DRY COOLING ◆ HEATING	
◆ “URURU” HUMIDIFY ◆ HUMID HEATING ◆ FAN ONLY	
To adjust the airflow	13
◆ To adjust the airflow rate ◆ To adjust the airflow direction	

Useful Functions

To operate wisely using the sensor.....	16
◆ 3 Area INTELLIGENT EYE ◆ AUTO OFF	
To use the timer	17
◆ ON/OFF TIMER ◆ COUNTDOWN OFF TIMER	
To ensure a comfortable sleep.....	19
◆ COMFORT SLEEP TIMER	
To guarantee high heating capacity when you wake up.....	21
◆ QUICK HEATING TIMER	
To increase the cooling or heating power.....	23
◆ POWERFUL	

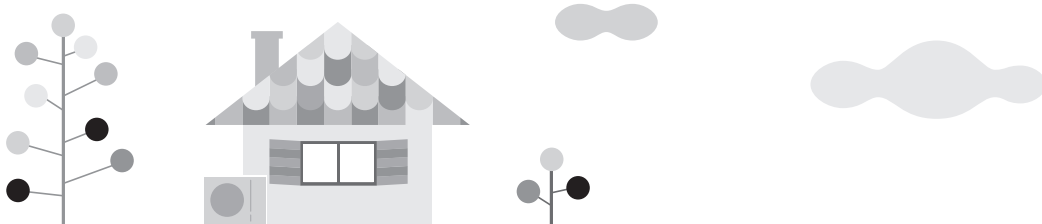

Tips for saving energy

- A. Cover windows with a blind or a curtain.**
Blocking sunlight and air from outdoors increases the cooling/heating effect.
- B. Be careful not to cool the room too much.**
Keeping the temperature setting at a moderate level helps save energy.
 - Recommended temperature setting
 - For cooling: 26-28°C
 - For heating: 20-24°C
- C. Keep air filter clean.**
Clogged air filters cause inefficient operation and waste energy. When the AUTO CLEANING FILTER operation is enabled, the air conditioner cleans the filter periodically. Efficient operation is available at any time without concerns about dirt. ▶ Page 28

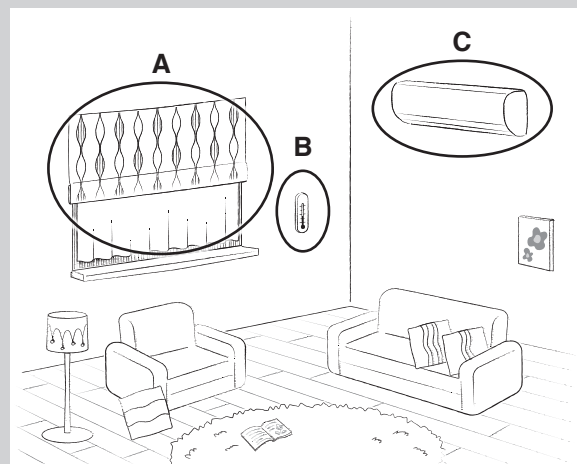

To purify the air in the room	24
◆ FLASH STREAMER AIR PURIFYING ◆ FRESH AIR SUPPLY VENTILATION	
To consider the environment of use	25
◆ ECONO ◆ OUTDOOR UNIT QUIET	
To keep the air conditioner clean	27
◆ MOLD PROOF ◆ CLEANING FILTER	
To know the status of your room and air conditioner.....	30
◆ INFORMATION	
To change the default settings	31
◆ Menu settings	

Cleaning

Cleaning (for service personnel)	35
< When the TIMER lamp (orange) blinks >	36
< When the MOLD PROOF / CLEANING FILTER lamp (green) blinks >	37

When the Need Arises

When the OPERATION lamp (green) blinks	40
FAQ	41
Troubleshooting (for service personnel)	42



The English text is the original instruction.
Other languages are translations of the original instructions.

Tips for your comfort

INTELLIGENT EYE sensor

When the INTELLIGENT EYE sensor is used, the sensor detects the movement of a person and adjusts the airflow direction and operation.

Do you want to direct the airflow away from you?

Do you want to save power consumption in a room with no person in it?

The sensor will cooperate with you. ▶ Page 15, 16



FLASH STREAMER



Flash streamer decomposes allergic substances.



It keeps air in the room and the inside of the air conditioner clean to make a comfortable space. ▶ Page 24

Safety precautions

	Read the precautions in this manual carefully before operating the unit.		This appliance is filled with R32.
---	---	---	---

- Keep this manual where the user can easily find it.
- The precautions described herein are classified as WARNING and CAUTION. They both contain important information regarding safety. Be sure to observe all precautions without fail.

	WARNING Failure to follow these instructions properly may result in personal injury or loss of life.
	CAUTION Failure to observe these instructions properly may result in property damage or personal injury, which may be serious depending on the circumstances.

	Never attempt.		Be sure to follow the instructions.		Be sure to establish an earth connection.
---	----------------	---	-------------------------------------	---	---

- After reading, keep this manual in a convenient place so that you can refer to it whenever necessary. If the equipment is transferred to a new user, be sure also to hand over the manual.

WARNING

- Do not use means to accelerate the defrosting process or to clean, other than those recommended by the manufacturer.
- The appliance must be stored in a room without continuously operating ignition sources (for example: open flames, an operating gas appliance or an operating electric heater).
 - Do not pierce or burn.
 - Be aware that refrigerants may not contain an odour.
- The appliance must be installed, operated and stored in a room with a floor area larger than 1.8m².
- In order to avoid fire, explosion or injury, do not operate the unit when harmful, among which flammable or corrosive gases, are detected near the unit.
- Be aware that prolonged, direct exposure to cool or warm air from the air conditioner, or to air that is too cool or too warm can be harmful to your physical condition and health.
- Do not place objects, including rods, your fingers, etc., in the air inlet or outlet. Product malfunctioning, product or injury damage may result due to contact with the air conditioner's high-speed fan blades.
- Do not attempt to repair, dismantle, reinstall or modify the air conditioner yourself as this may result in water leakage, electric shocks or fire hazards.
- Do not use flammable spray near the air conditioner, or otherwise fire may result.
- Do not use a refrigerant other than the one indicated on the outdoor unit (R32) when installing, moving or repairing. Using other refrigerants may cause trouble or damage to the unit, and personal injury.
- To avoid electric shocks, do not operate with wet hands.

- Beware of fire in case of refrigerant leakage. If the air conditioner is not operating correctly, i.e. not generating cool or warm air, refrigerant leakage could be the cause. Consult your dealer for assistance. The refrigerant within the air conditioner is safe and normally does not leak. However, in the event of a leakage, contact with a naked burner, heater or cooker may result in generation of noxious gas. Do not use the air conditioner until a qualified service person confirms that the leakage has been repaired.
- Do not attempt to install or repair the air conditioner yourself. Improper workmanship may result in water leakage, electric shocks or fire hazards. Please contact your local dealer or qualified personnel for installation and maintenance work.
- When the air conditioner is malfunctioning (giving off a burning odour, etc.) turn off power to the unit and contact your local dealer. Continued operation under such circumstances may result in a failure, electric shocks or fire hazards.
- Be sure to install an earth leakage circuit breaker. Failure to install the earth leakage circuit breaker may result in electric shocks or fire.

- Be sure to earth the unit. Do not earth the unit to a utility pipe, lightning conductor or telephone earth lead. Imperfect earthing may result in electric shocks.

CAUTION

- Do not use the air conditioner for purposes other than those for which it is intended. Do not use the air conditioner for cooling precision instruments, food, plants, animals or works of art as this may adversely affect the performance, quality and/or longevity of the object concerned.
 - Do not expose plants or animals directly to airflow from the unit as this may cause adverse effects.



- Do not place appliances that produce naked flames in places exposed to the airflow from the unit as this may impair combustion of the burner.
- Do not block air inlets nor outlets. Impaired airflow may result in insufficient performance or trouble.
- Do not sit on the outdoor unit, put things on the unit, or pull the unit. Doing so may cause accidents, such as falling or toppling down, thus resulting in injury, product malfunctioning, or product damage.
- Do not place objects that are susceptible to moisture directly beneath the indoor or outdoor units. Under certain conditions, condensation on the main unit or refrigerant pipes, air filter dirt or drain blockage may cause dripping, resulting in fouling or failure of the object concerned.
- After prolonged use, check the unit stand and its mounts for damage. If they are left in a damaged condition, the unit may fall and cause injury.
- To avoid injury, do not touch the air inlet or aluminium fins of the indoor or outdoor units.
- The appliance is not intended for use by unattended young children or infirm persons. Impairment of bodily functions and harm to health may result.
- Children should be supervised to ensure that they do not play with the unit or its remote controller. Accidental operation by a child may result in impairment of bodily functions and harm health.
- Avoid impacts to the indoor and outdoor units, or otherwise product damage may result.
- Do not place flammable items, such as spray cans, within 1m of the air outlet. The spray cans may explode as a result of hot air from the indoor or outdoor units.
- Be careful not to let pets urinate on the air conditioner. Urination on the air conditioner may result in electric shocks or fire.
- Do not wash the air conditioner with water, as this may result in electric shocks or fire.
- Do not place water containers (vases etc.) above the unit, as this may result in electric shocks or fire hazards.



- To avoid oxygen depletion, ensure that the room is adequately ventilated if equipment such as a burner is used together with the air conditioner.
- Before cleaning, be sure to stop unit operation, turn off the circuit breaker or remove the power cord. Otherwise, an electric shock and injury may result.
- Only connect the air conditioner to the specified power supply circuit. Power supplies other than the one specified may result in electric shocks, overheating and fires.
- Arrange the drain hose to ensure smooth drainage. Imperfect drainage may cause wetting of the building, furniture etc.
- Do not place objects in direct proximity of the outdoor unit and do not let leaves and other debris accumulate around the unit. Leaves are a hotbed for small animals which can enter the unit. Once in the unit, such animals can cause malfunctions, smoke or fire when making contact with electrical parts.
- Do not place objects around the indoor unit. Doing so may have an adverse influence on the performance, product quality, and life of the air conditioner.
- This appliance is not intended to be used by persons with reduced physical, sensory or mental capabilities, or with lack of operation knowledge, unless they have been given supervision or instruction concerning the appliance use by person responsible for their safety. Keep out of children's reach to ensure that they do not play with the appliance.
- For care and cleaning, call service personnel.

P002

This is an appliance that is not accessible to the general public.

Installation site

< To install the air conditioner in the following types of environments, consult the dealer >

- Places with an oily environment or where steam or soot occurs.
- Salty environment such as coastal areas.
- Places where sulfide gas occurs such as hot springs.
- Places where snow may block the outdoor unit.
- The indoor unit is at least 1m away from any television or radio set (unit may cause interference with the picture or sound).
- The drain from the outdoor unit must be discharged to a place of good drainage.

Consider nuisance to your neighbours from noises

< For installation, choose a place as described below >

- A place solid enough to bear the weight of the unit which does not amplify the operating sound or vibration.
- A place from where the air discharged from the outdoor unit or the operating sound will not annoy your neighbours.

Electrical work

- For power supply, be sure to use a separate power circuit dedicated to the air conditioner.

System relocation

- Relocating the air conditioner requires specialized knowledge and skills. Please consult the dealer if relocation is necessary for moving or remodeling.

Names and functions of parts

Indoor unit

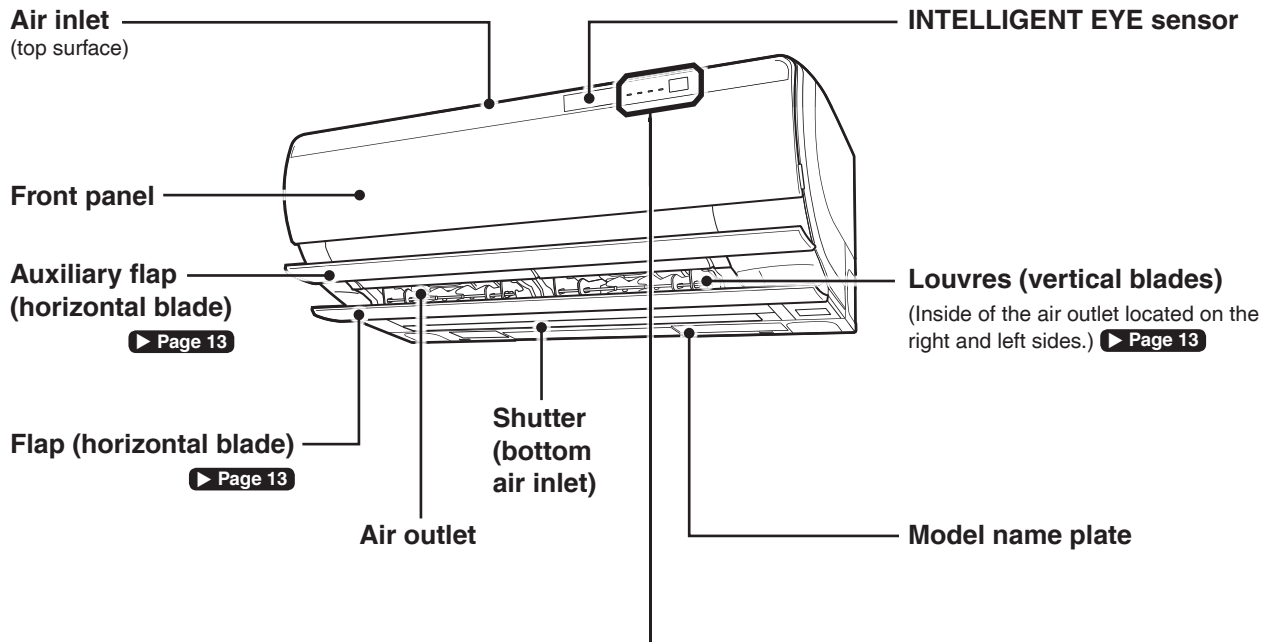

■ Display

**MOLD PROOF /
CLEANING FILTER lamp** (green)

QUICK HEATING TIMER lamp (red)

OPERATION lamp (green)

TIMER lamp (orange)

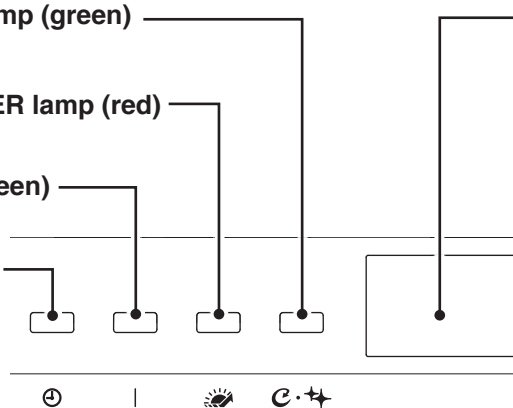

Transmitter/Receiver

- Sends/receives signals to/from the remote controller.
- The OPERATION lamp blinks with beep sound to indicate signal reception.

Case	Sound type
Operation start	beep-beep
Setting change	beep
Operation stop	long beep

< List of lamps >

Lamp	Colour	State	Description
TIMER lamp	orange	Lights up	TIMER is set. ▶ Page 17
		Blinks	It is time to clean the streamer unit. ▶ Page 36
OPERATION lamp	green	Lights up	The air conditioner is running.
		Blinks	Check the error code. ▶ Page 40
QUICK HEATING TIMER lamp	dark red	Lights up	QUICK HEATING TIMER is set. ▶ Page 21
	bright red		Preparatory heating operation or QUICK HEATING TIMER operation is running. ▶ Page 21
MOLD PROOF / CLEANING FILTER lamp	green	Lights up	The air conditioner is running with the AUTO MOLD PROOF set to "On". ▶ Page 27
			MOLD PROOF operation or CLEANING FILTER operation is running. ▶ Page 27, 28
		Blinks	It is time to clean the dust box. ▶ Page 37

When the front panel is open ▶ Page 35

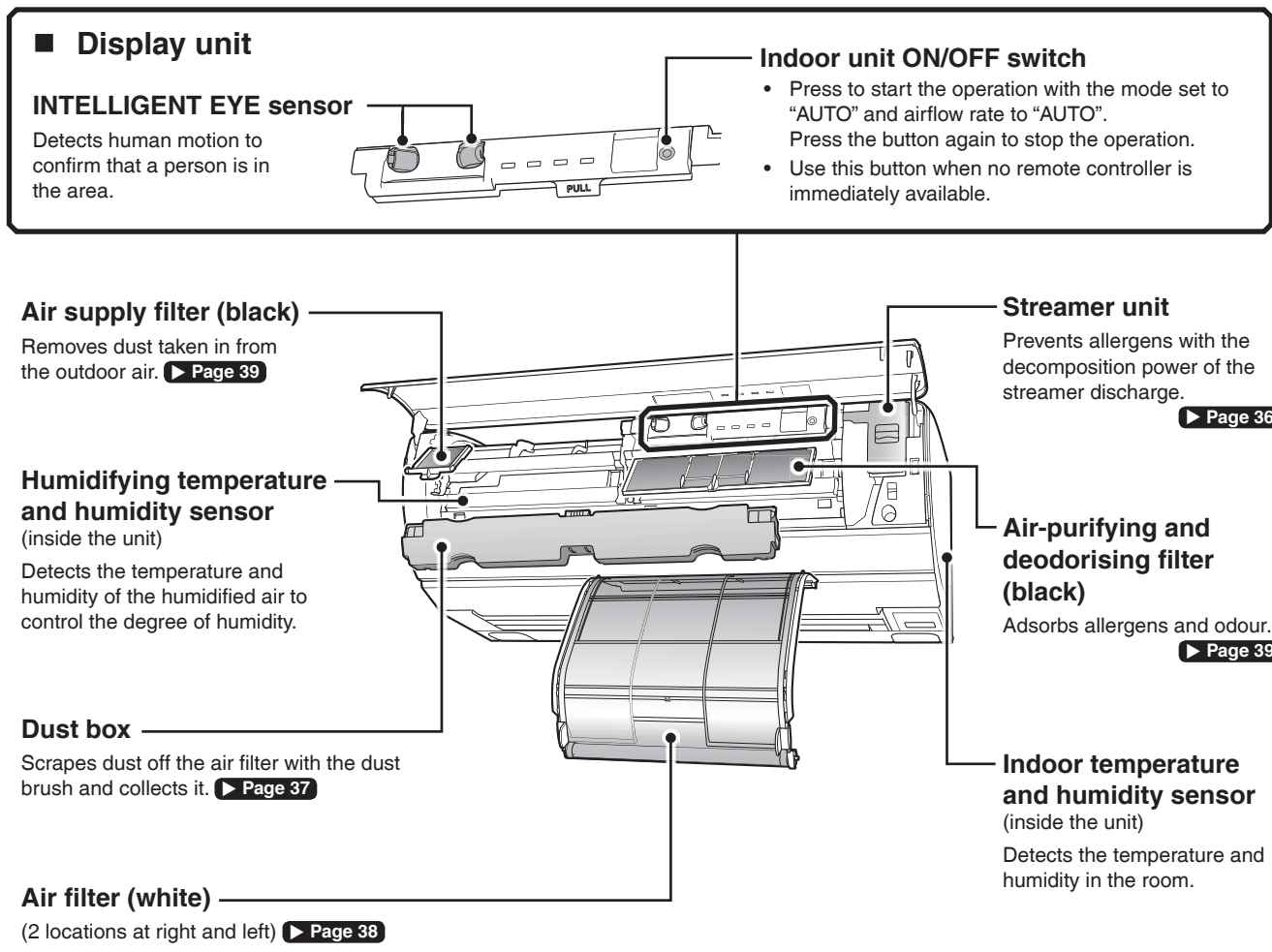

Outdoor unit

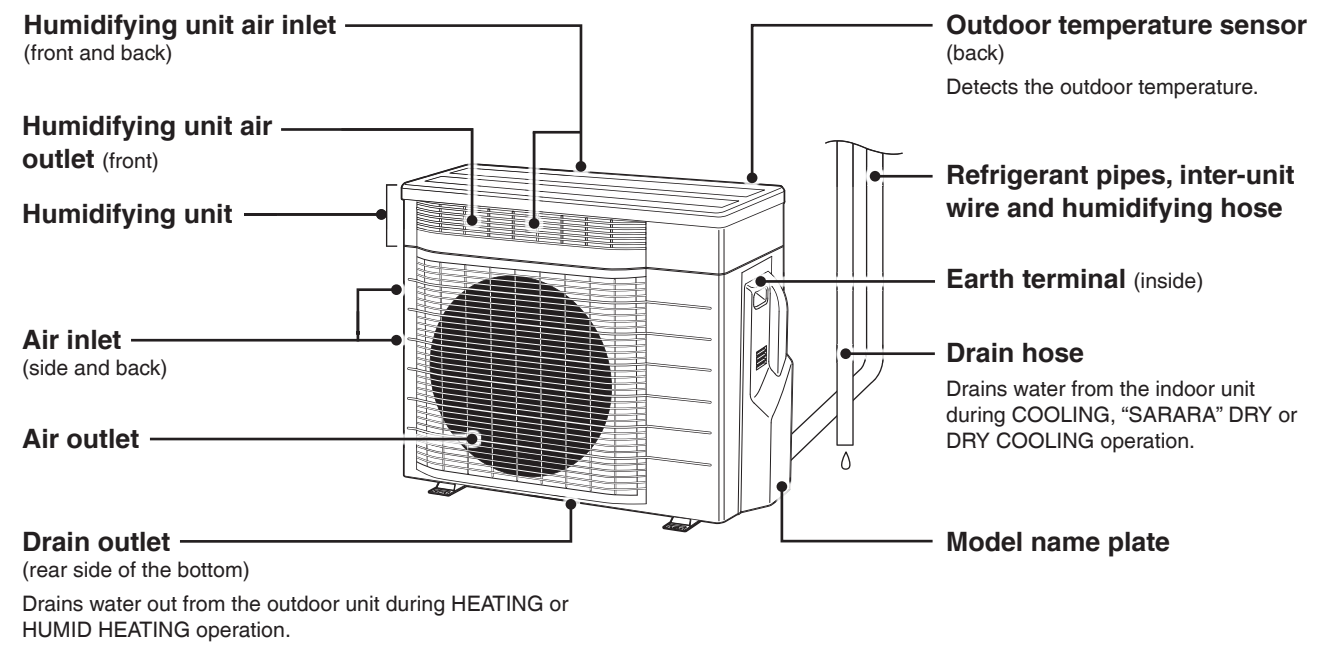

Names and functions of parts

Remote controller

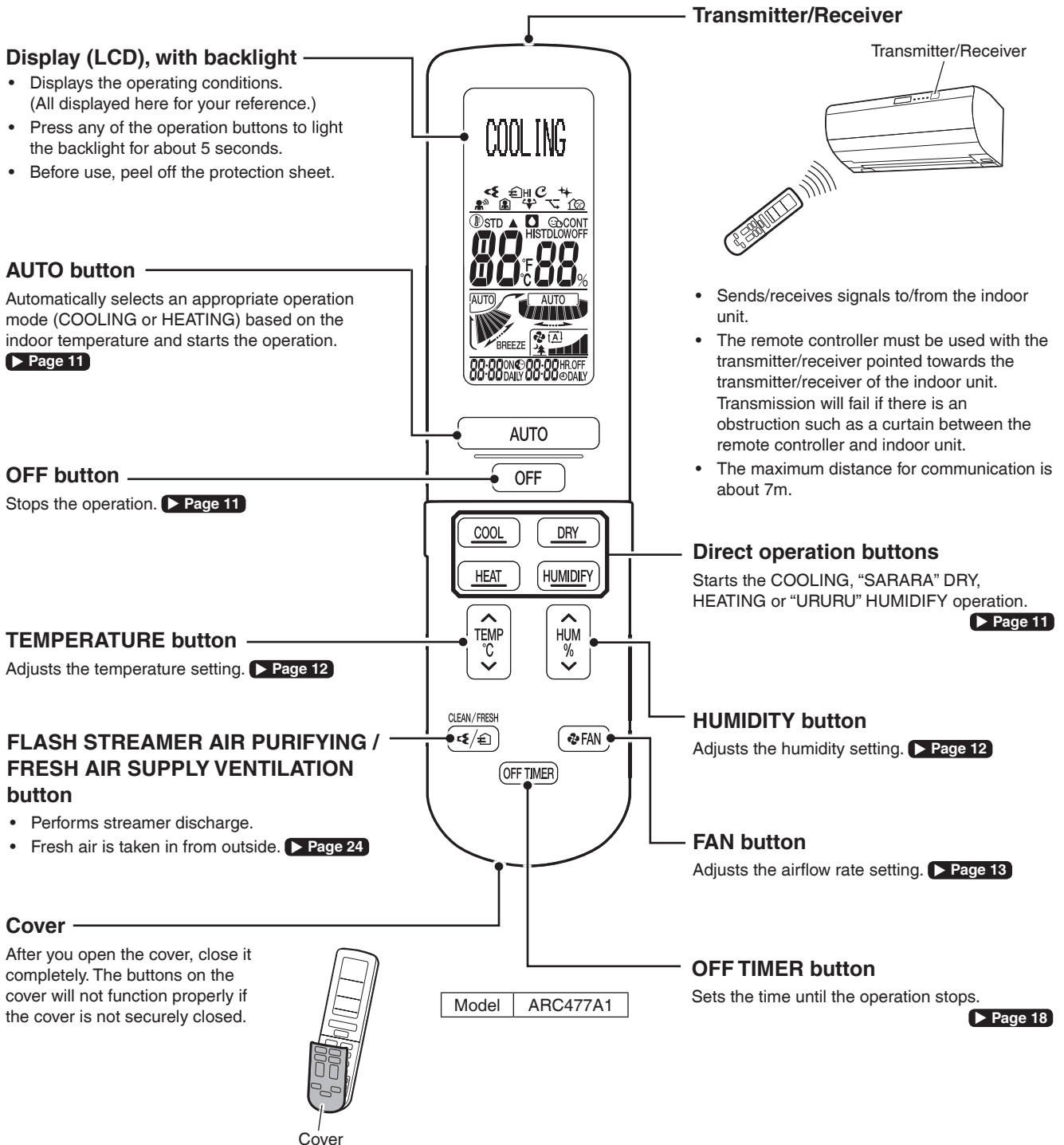

Notes on remote controller

- Take care to avoid dropping the remote controller or getting it wet. (Dropping or getting it wet may break it.)
- When the remote controller gets dirty, wipe it with a dry soft cloth.
- Signal communication may become poor if an electronic-starter-type fluorescent lamp (such as inverter-type lamps) or TV is in the room. Consult the service shop if that is the case.
- The sensitivity may become poor if the transmitter/receiver is exposed to direct sunlight.

Open the cover

Airflow direction buttons

Adjust the vertical and horizontal airflow directions. ▶ Page 13

SENSOR button

- : Detects a person and adjusts the airflow direction.
- : Automatically switches the unit off when no presence is detected. ▶ Page 16

FAN ONLY button

Performs FAN ONLY operation. ▶ Page 11

POWERFUL button

Increases the airflow rate in the COOLING or HEATING operation. ▶ Page 23

RESET button

Resets the dust box cleaning indicator and streamer unit cleaning indicator. ▶ Page 36, 37

▲	A menu item is shown above.
▼	A menu item is shown below.
	FLASH STREAMER AIR PURIFYING ▶ Page 24
	FRESH AIR SUPPLY VENTILATION ▶ Page 24
	AUTO MOLD PROOF ▶ Page 27
	AUTO CLEANING FILTER ▶ Page 28
	3 Area INTELLIGENT EYE ▶ Page 16
	AUTO OFF ▶ Page 16
	POWERFUL ▶ Page 23
	ECONO ▶ Page 25
	OUTDOOR UNIT QUIET ▶ Page 25
1/12	The number of menu items. ▶ Page 31

ECONO/QUIET button

- : Limits the maximum power consumption.
- : Reduces the noise from the outdoor unit. ▶ Page 25

MOLD PROOF button

Reduces mold and odour inside the unit. ▶ Page 27

CLEANING FILTER button

Removes dirt such as dust attached to the air filter. ▶ Page 28

CLOCK button

Sets the time of the clock. ▶ Page 10

	INFORMATION button Provides information such as temperature and power consumption. ▶ Page 30		SET UP button Shows the SET UP display. ▶ Page 31		BRIGHTNESS button Sets the brightness of the indoor unit lamps. ▶ Page 10
	TIMER button Sets the TIMERS. ▶ Page 17, 19, 21		SELECT button Selects items.		APPLY button Completes the remote controller operation.
	PREVIOUS button Goes back to the previous display.				CANCEL button Exits the SET UP display. Cancels the timer settings.

Preparation before operation

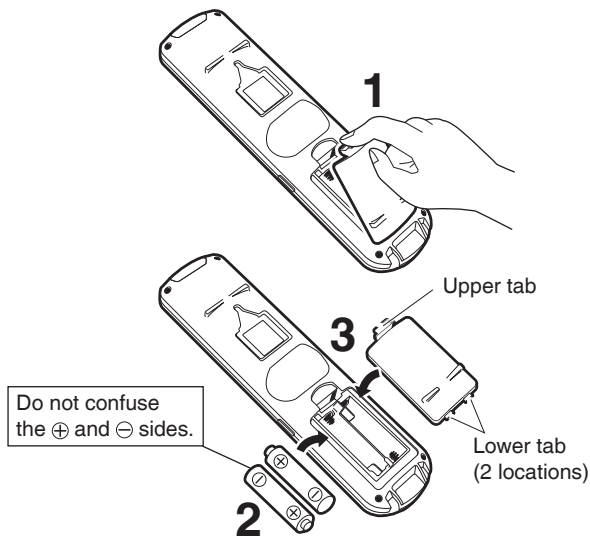

To set the batteries

1. Pull down the upper tab to open the cover.
2. Insert 2 dry batteries AA.LR6 (alkaline).
 - Using batteries other than AA.LR6 (alkaline) may lead to improper operation.
3. Insert the 2 lower tabs on the cover to put the cover back in place.

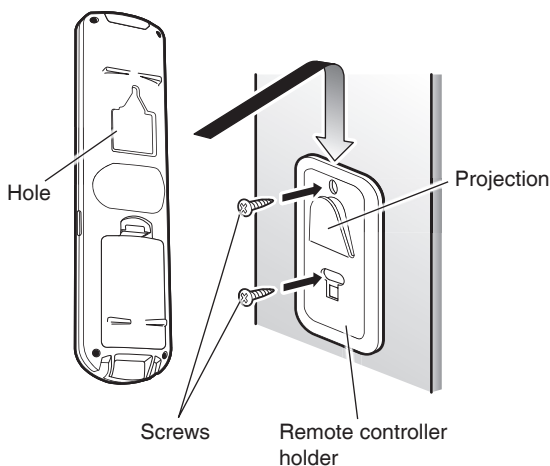

To fix the remote controller holder to a wall

1. Choose a place where the signals can reach the unit.
2. Fix the remote controller holder to a wall, a pillar, or similar location with the screws procured locally.
3. Fit the projection of the remote controller holder into the hole at the back of the remote controller.

Turn on the circuit breaker

- After the power is turned on, the flaps of the indoor unit open and close once to set the reference position.

Notes on batteries

- The batteries will last for about 1 year. If the remote controller display begins to fade and the reception degrades within 1 year, however, replace both batteries with new AA.LR6 (alkaline) ones at the same time.
- The batteries that come with the remote controller are for initial operation. The batteries may run out in less than 1 year.
- When the TIMERS are set, the settings are cancelled after replacing the batteries. Set the TIMERS again.
- When the air conditioner is not used for a long time, take the batteries out.

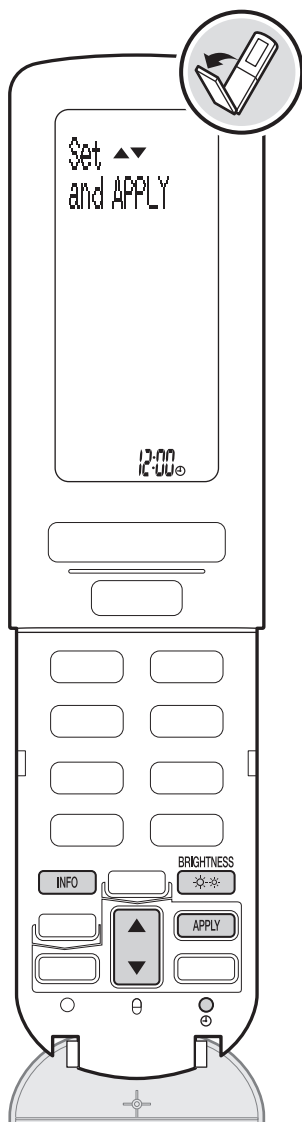

To set the clock

1. Press .

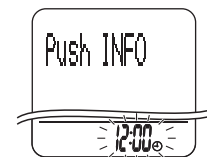

2. Press to set the clock to the current time.

- Each time you press , the time changes by 1 minute. If you press and hold the button, the time changes by 10 minutes.



3. Press .

- After "🕒 CLOCK Set" appears, the normal screen is displayed again.

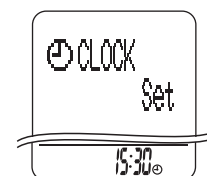

< To set the clock after replacing the batteries >

When the clock is set, the set time is saved in the indoor unit. After replacing the batteries, direct the remote controller toward the indoor unit and press . (The time will be set automatically.) If "12:00" keeps on blinking, follow steps 1 to 3 above.

To set the position where the indoor unit is installed

➤ Set "INSTALLED POSITION" in the menu settings.

- To adjust the airflow properly, set the "INSTALLED POSITION". ▶ Page 31, 33

To set the brightness of the indoor unit lamps

➤ Press .

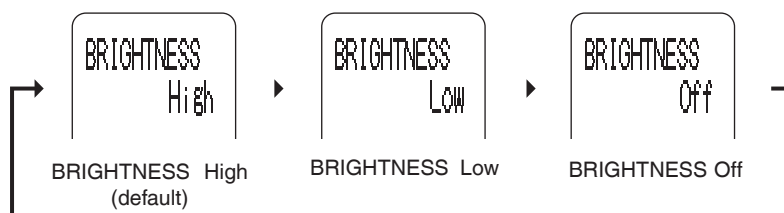

Note on setting the clock

- If the indoor unit's internal clock is not set to the correct time, the ON/OFF TIMER, COMFORT SLEEP TIMER and QUICK HEATING TIMER will not operate punctually.

To set operation modes

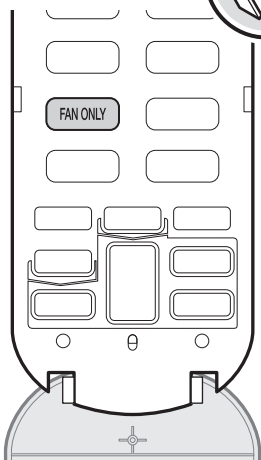
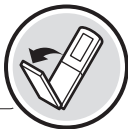
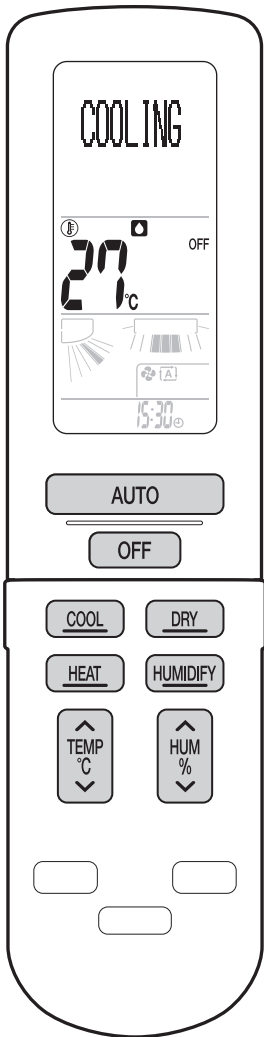

OPERATION lamp (green)

AUTO operation

To operate in appropriate operation mode (COOLING or HEATING) based on the set temperature and the indoor temperature.

Press **AUTO**.

AUTO

COOLING operation

To lower the temperature.

Press **COOL**.

COOLING

“SARARA” DRY operation

To lower the humidity.

Press **DRY**.

DRY

DRY COOLING operation

To lower the temperature and humidity.

Press **↓%** during COOLING operation.

- Press **TEMP °C** during “SARARA” DRY operation to switch the operation to DRY COOLING.

DRY
COOLING

HEATING operation

To raise the temperature.

Press **HEAT**.

HEATING

“URURU” HUMIDIFY operation

To raise the humidity.

Press **HUMIDIFY** while the unit is not operating.

HUMIDIFY

HUMID HEATING operation

To raise the temperature and humidity.

Press **HUMIDIFY** during HEATING operation.

- Press the button again to go back to HEATING operation.
- Press **HUM** during HEATING operation or **TEMP °C** during “URURU” HUMIDIFY operation to switch the operation to HUMID HEATING.

HUMID
HEATING

FAN ONLY operation

To blow air.

Press **FAN ONLY**.

FAN ONLY

< To stop the operation >

Press **OFF**.

To adjust the temperature

Press .

To adjust the humidity

Press .

Notes on humidity settings

Setting	Description
 : MOISTURISING	Keeps the humidity high and does not blow air directly on the body to make the operation gentle to your skin. The operation is recommended when you are worried about the dryness of your skin. The airflow rate cannot be changed.
CONT : CONTINUOUS	Continues humidifying or dehumidifying.
HI : HIGH	Humidifies or dehumidifies with high power.
STD : STANDARD	Humidifies or dehumidifies with moderate power.
LOW : LOW	Humidifies or dehumidifies with low power.
OFF : OFF	Does not perform humidity control.

Notes on temperature and humidity settings in each operation mode

Mode	Temperature	Humidity
AUTO	18-30°C	The humidity setting is not available.
COOLING	18-32°C	*3
DRY COOLING		MOISTURISING, CONTINUOUS, LOW, STANDARD, HIGH or OFF *4
“SARARA” DRY	*1	CONTINUOUS, LOW, STANDARD or HIGH
HEATING	10-30°C	*5
HUMID HEATING		OFF *6, LOW, STANDARD, HIGH, CONTINUOUS or MOISTURISING
“URURU” HUMIDIFY		LOW, STANDARD, HIGH or CONTINUOUS

*1 When the temperature is changed, the DRY COOLING operation starts.

*2 When the temperature is changed, the HUMID HEATING operation starts.

*3 When the humidity is lowered, the DRY COOLING operation starts.

*4 When “OFF” is selected, the COOLING operation starts.

*5 When the humidity is raised, the HUMID HEATING operation starts.

*6 When “OFF” is selected, the HEATING operation starts.

Notes on “SARARA” DRY operation

- This mode mixes dehumidified cool air with room air to adjust the air outlet temperature and remove moisture.
- When the indoor temperature rises, the DRY COOLING operation automatically starts.
- When the outdoor temperature is lower than the indoor temperature, dehumidifying is less effective.
- When the outdoor temperature is lower than 18°C, the room is dehumidified by alternating the COOLING and HEATING operations. In addition, the ventilation is controlled properly and the room humidity is lowered by taking outdoor air into the room. (Air intake dehumidifying)

Notes on DRY COOLING operation

- In order to lower the humidity, the airflow rate during the DRY COOLING operation becomes lower than that in the COOLING operation.
- When the humidity is not lowered, “SARARA” DRY operation automatically starts.

Note on “URURU” HUMIDIFY operation

- The humidifying unit collects moisture from the outdoor air to humidify the room.

Note on HUMID HEATING operation

- When the indoor temperature rises by HEATING operation, the indoor humidity may drop temporarily.

To adjust the airflow

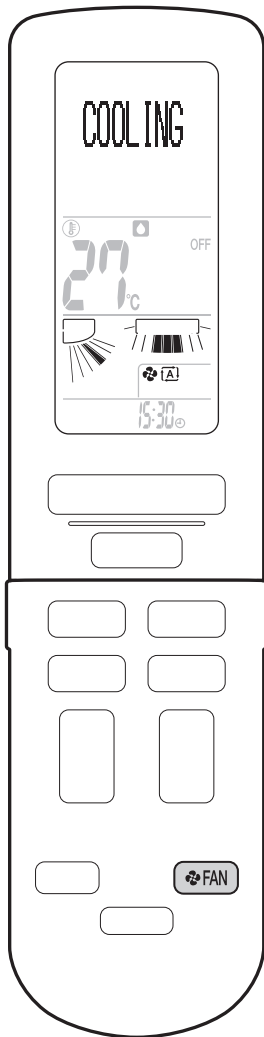

To adjust the airflow rate

Press .

- Each time you press the button, the airflow rate indicator changes. (Some indicators may not appear depending on the operation mode. [▶ Page 14](#))



- When the airflow is set to “”, indoor unit quiet operation will start and the operating sound from the unit will become quieter.
- If the temperature does not reach the desired point, change the airflow rate setting.

To adjust the airflow direction

< To change the vertical airflow direction >

Press .

- Each time you press the button, the airflow direction indicator changes. (Some indicators may not appear depending on the operation mode. [▶ Page 14](#))
- The flaps move vertically.

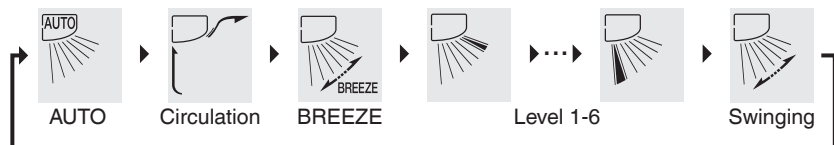

< To change the horizontal airflow direction >

Press .

- Each time you press the button, the airflow direction indicator changes. (Some indicators may not appear depending on the setting of “INSTALLED POSITION”. [▶ Page 33](#))
- The louvres move horizontally.

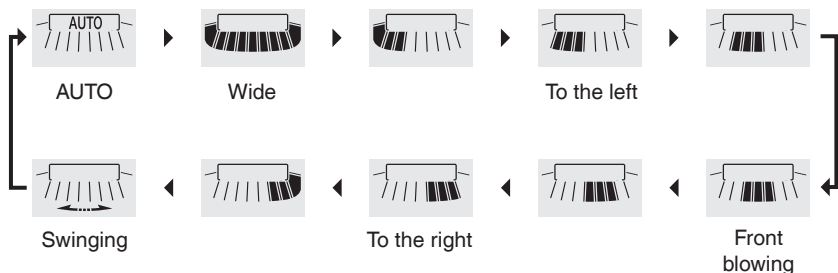

< To combine vertical and horizontal airflow directions (3-D airflow) >

Set the vertical and horizontal airflow directions to “Swinging”.

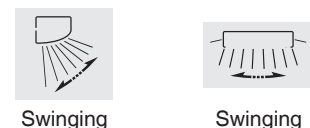

- The flaps and louvres move alternately.
- To cancel 3-D airflow, press or .

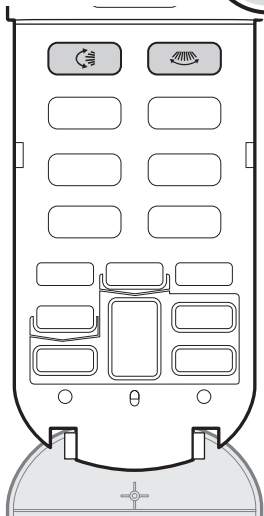

Notes on airflow rate

- When the airflow rate setting is “AUTO”, starting COOLING, “SARARA” DRY, or DRY COOLING operation (including the operation selected with “AUTO”) triggers the deodorising function which reduces odour coming from the indoor unit and the unit does not blow air immediately. Wait for about 40 seconds. (SMELL PROOF)
- When the airflow rate is lowered, the flaps and louvres will stop. When the vertical airflow direction is set to “Swinging”, the flaps stop in an upward direction.
- At smaller airflow rates, the cooling/heating effect is also smaller.

< Airflow rate settings in each operation mode >

Mode	Airflow rate setting
“SARARA” DRY / DRY COOLING	AUTO
AUTO / COOLING / HEATING / “URURU” HUMIDIFY / HUMID HEATING* / FAN ONLY	AUTO, Indoor unit quiet, Airflow rate 1-5

* When the humidity is set to “MOISTURISING”, the airflow rate becomes “AUTO”.

Notes on vertical airflow direction

“AUTO”, “Circulation” and “BREEZE” airflow can be set according to the operation mode.

■ Circulation airflow



This setting blows air far using the space of the ceiling. Moreover, air can be circulated in the whole room by taking air from the shutter (bottom air inlet), to eliminate the temperature variation.

■ BREEZE airflow



This setting automatically adjusts the airflow rate and vertical airflow direction to generate a breeze-like airflow. It is a comfortable airflow even when it blows on your body.

< Settings of “AUTO”, “Circulation”, and “BREEZE” airflow in each operation mode >

Mode	Airflow direction setting		
	AUTO	Circulation	BREEZE
AUTO	✓	–	–
COOLING / “SARARA” DRY / DRY COOLING	✓	✓	✓
HEATING / “URURU” HUMIDIFY / HUMID HEATING	✓	–	–
FAN ONLY	–	✓	✓

< Settings of “AUTO” airflow in each operation mode >

Mode	Airflow direction setting	
COOLING / DRY COOLING	Circulation airflow ► BREEZE airflow	
HEATING / HUMID HEATING	Downward air blowing and circulation airflow are repeated.	
“SARARA” DRY	When the indoor temperature is a little lower	Circulation airflow
	When the indoor temperature is a little higher	BREEZE airflow
“URURU” HUMIDIFY	Circulation	

< Movable range of the flaps >

The movable range of the flaps varies according to the operation mode.

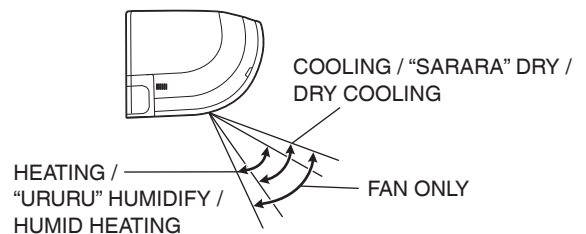

⚠ CAUTION

- Always use a remote controller to adjust the angles of the flaps and louvres. If you attempt to move the flaps and louvres forcibly by hand when they are swinging, the mechanism may be damaged.
- Always use a remote controller to adjust the louvres angles. Inside the air outlet, a fan is rotating at a high speed.

To adjust the airflow

Note on 3-D airflow

- Using 3-D airflow circulates cold air, which tends to collect at the bottom of the room, and hot air, which tends to collect near the ceiling, throughout the room, preventing areas of cold and hot developing.

Note on horizontal airflow direction

- When the horizontal airflow direction is set to "AUTO", the INTELLIGENT EYE sensor is activated. The INTELLIGENT EYE sensor detects a person in the left-side, front, and right-side areas and directs the airflow away from that person.

< INTELLIGENT EYE sensor >

The INTELLIGENT EYE sensor detects the movements of a person (heat-generating object) to confirm where people are.

Example (for Comfort) [▶ Page 16](#)

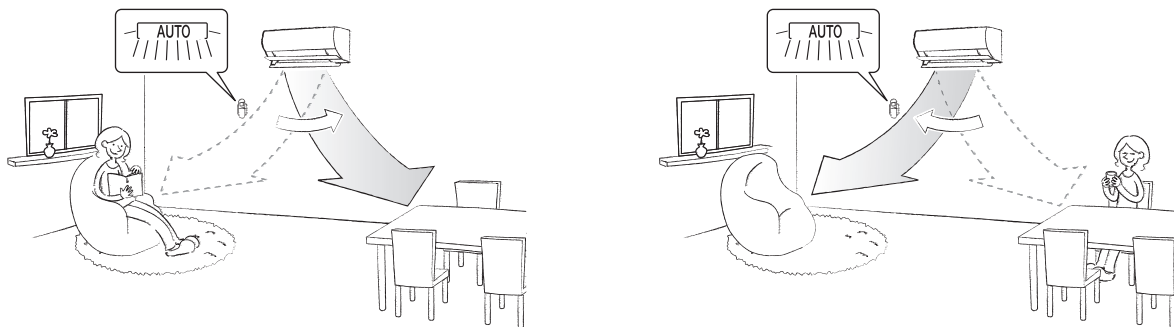

- The maximum distance that people can be detected is about 9m in front of the indoor unit.
- The movement of small animals including dogs and cats or a temperature change due to a heat-generating object such as another heating appliance or electrical appliance may incorrectly be detected as a person. In addition, areas exposed to sunlight may incorrectly be detected as a person.
- If several persons are detected in the same room, the airflow direction is changed based on the position of the last detected person.
- The area just under or right beside the indoor unit cannot be detected.
- Application range is as follows.

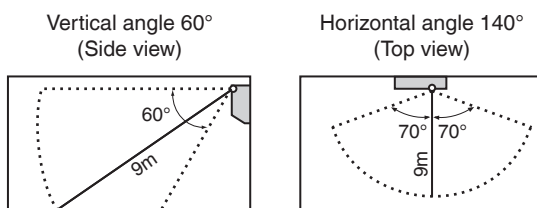

To operate wisely using the sensor

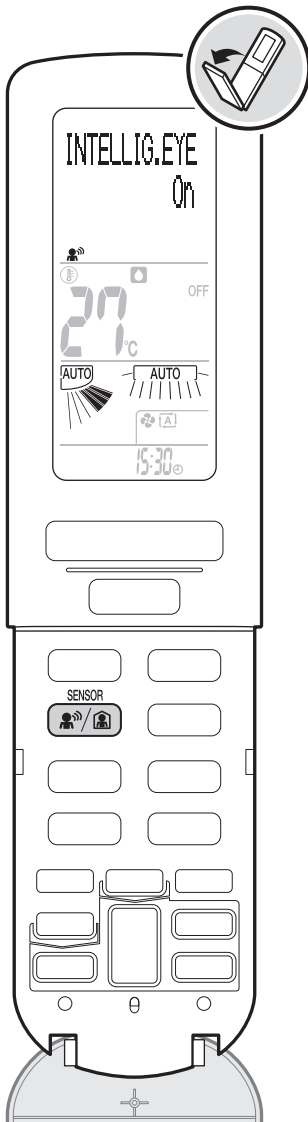

3 Area INTELLIGENT EYE operation

Whether to blow air away from a person or not can be set according to your preference. The INTELLIGENT EYE sensor detects the movement of a person and automatically changes the airflow direction.

AUTO OFF operation

When the INTELLIGENT EYE sensor judges that there is no one in the room, it changes the set temperature +2°C in COOLING / -2°C in HEATING operation. When the set time elapses with no change in the condition, the air conditioner automatically stops the operation.

< To use the operation >

Press  and select the setting of your preference.

- Each time you press the button, the setting changes.

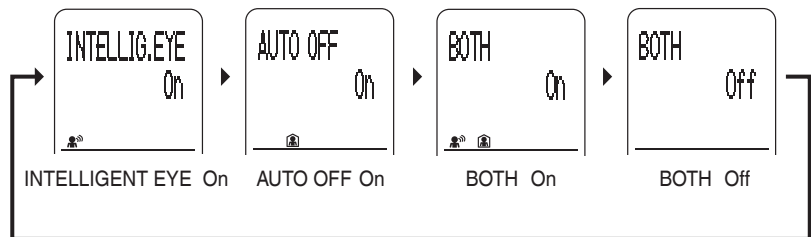

- “”, “”, or “” is displayed on the LCD.

Settings of 3 Area INTELLIGENT EYE

Focus	Blows air on a person.
Comfort *	Does not blow air on a person.

* Default setting

You can change the setting at “INTELLIG.EYE AIRFLOW” of the menu settings. [▶ Page 31, 32](#)

Settings of AUTO OFF

1 HR *	Stops the operation 1 hour after the sensor judges that there is no one in the room.
3 HR	Stops the operation 3 hours after the sensor judges that there is no one in the room.

* Default setting

You can change the setting at “AUTO OFF time” of the menu settings. [▶ Page 31, 32](#)

< To cancel the operation >

Press  and select “BOTH Off”.

- “”, “”, or “” disappears from the LCD.

Note on 3 Area INTELLIGENT EYE operation

- POWERFUL operation is cancelled when 3 Area INTELLIGENT EYE is selected.

Note on 3 Area INTELLIGENT EYE and AUTO OFF operations

- If no presence detected in the room for 20 minutes, the air conditioner changes the set temperature +2°C in COOLING / -2°C in HEATING operation.
When the indoor temperature exceeds 30°C, the operation changes the temperature +1°C in COOLING operation from set temperature.

To use the timer

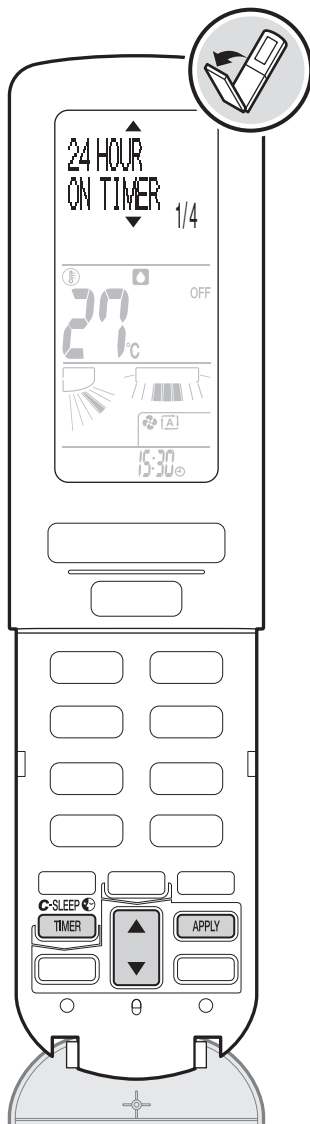

TIMER lamp (orange)

ON/OFF TIMER operation

This function controls the operation start and stop time.

When you set the timer, you can select the operation frequency either once or daily.

< To use the operation >

1. Press .

2. Press to select the item and press .

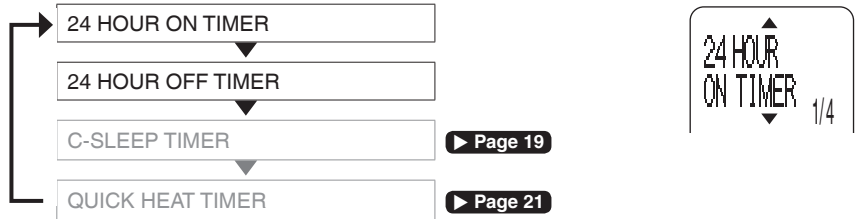

3. Press to select the item and press .

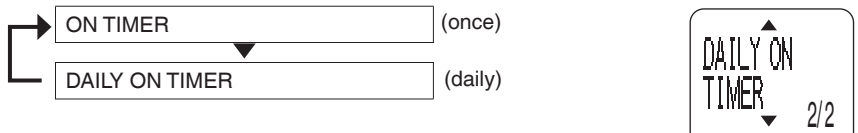

4. Press to set the start/stop time and press .

- The time that was set last is displayed (from the second time).
- Each time you press , the time changes by 10 minutes. If you press and hold the button, the time changes continuously.
- After setting, the set time and "ON" or "OFF" are displayed on the LCD. When daily is selected, "DAILY" is displayed on the LCD as well.
- The TIMER lamp (orange) lights up.



< To change or cancel the setting >

1. Follow steps 1 and 2 above and then select the **TIMER** you want to change.

2. Press to select the item and press .

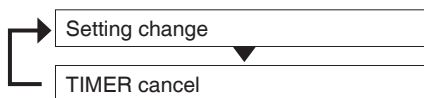

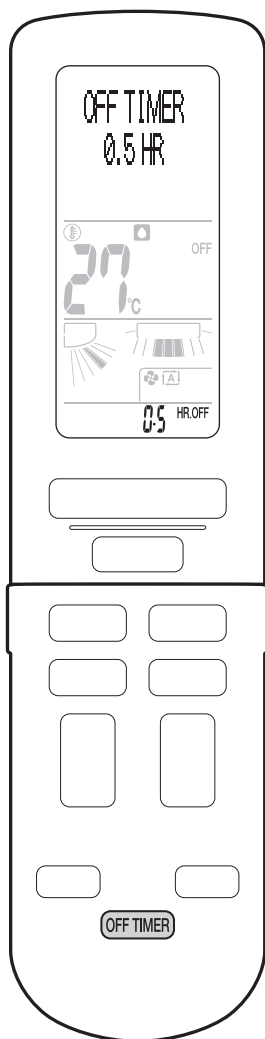

COUNTDOWN OFF TIMER operation

You can set the timer for the remaining time until the scheduled stop.
The timer should be set each time.

< To use the operation >

Press **OFF TIMER**.

- The time can be set in increments of 30 minutes each time the button is pressed (from 30 minutes to 9 hours 30 minutes).

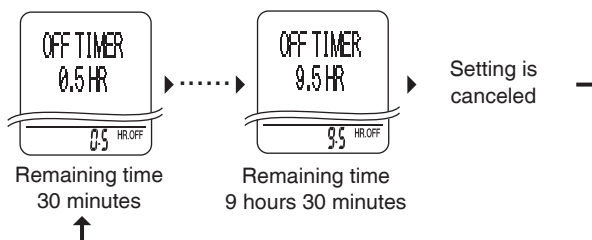

- “OFF” and remaining time until the scheduled stop are displayed on the LCD.
- The TIMER lamp (orange) lights up.

< To cancel the setting >

Press **OFF TIMER** until the setting is canceled.

- The TIMER lamp goes out.

< To combine ON and OFF / COUNTDOWN OFF TIMER operation >

You can combine the ON and OFF / COUNTDOWN OFF TIMERS.

Example

Current time: 23:00 (Air conditioner is operating.)

- OFF TIMER is set to 0:00 (or COUNTDOWN OFF TIMER is set to turn off the unit after 1 hour).
- ON TIMER is set to 7:00.

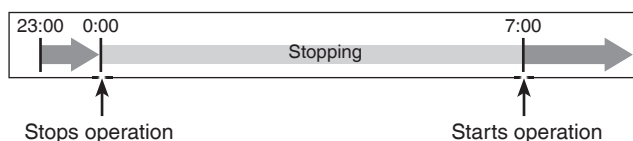

TIMER lamp (orange)

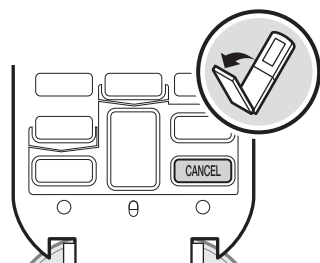

< To cancel all TIMER settings >

Press **CANCEL**.

- The TIMER lamp goes out.
- If the menu screen is open, press **CANCEL** twice.

Notes on TIMER operation

- If the COUNTDOWN OFF TIMER and OFF TIMER (once) are set simultaneously, priority is given to the timer set later.
- If you do not use the air conditioner for a long time, cancel the daily timer.
- If you change the frequency of the timer operation, cancel the present timer setting first and then set the timer again.
- When the TIMER lamp blinks, clean the streamer unit. ▶ [Page 36](#)
- In the following cases, set the timer again. (The timer is reset.)
 - Power failure.
 - The circuit breaker has been activated.
 - The circuit breaker has been turned off.
 - Batteries of the remote controller have been replaced.

To ensure a comfortable sleep

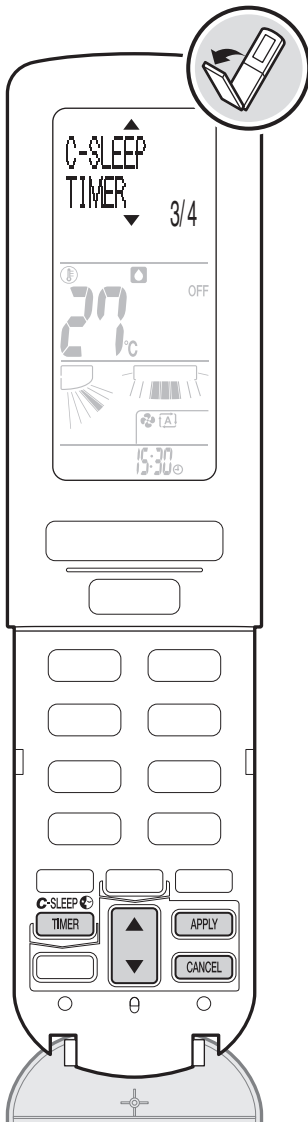

COMFORT SLEEP TIMER operation

COMFORT SLEEP TIMER operation keeps the indoor temperature and humidity at suitable levels for a comfortable sleep and refreshing morning.



< To use the operation >

1. Press  during COOLING or HEATING operation.

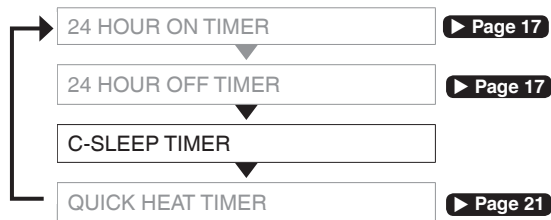
2. Press  to select the item and press  .



3. Press  to set the wake-up time and press  .

- The time that was set last is displayed (from the second time).
- Each time you press , the time changes by 10 minutes. If you press and hold the button, the time changes continuously.
- When this timer is set, the wake-up time and “” are displayed on the LCD.

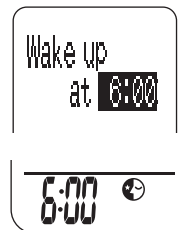



< To change or cancel the setting >

1. Follow steps 1 and 2 above and then select the TIMER you want to change.

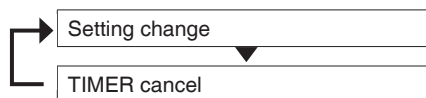
2. Press  to select the item and press  .



- Settings can be cancelled with .
- If the menu screen is open, press  twice.

Notes on COMFORT SLEEP TIMER operation

- When COMFORT SLEEP TIMER is set, the upper limit of the set temperature of HUMID HEATING is 22°C.
- After the COMFORT SLEEP TIMER operation is finished, the operation displayed on the remote controller will continue.
- If you set the COMFORT SLEEP TIMER while the ON TIMER is set, the ON TIMER will be cancelled.

< Temperature control of COMFORT SLEEP TIMER operation >

- Once COMFORT SLEEP TIMER operation starts, the temperature will be lowered 2°C in the next 3 hours, and then raised 1°C one hour before you wake up. (V-shaped temperature control)

Example (for 6 hours of sleep)

V-shaped temperature control works most effectively over periods of 4 or more hours of sleep.

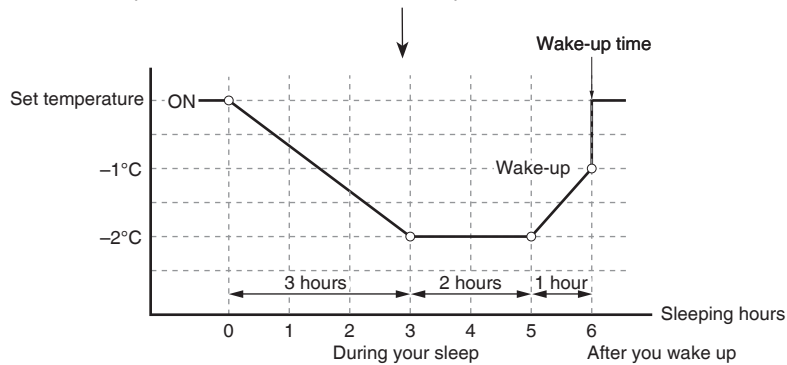

< Humidity control of COMFORT SLEEP TIMER operation >

- In DRY COOLING and HUMID HEATING operations, humidity is controlled based on the standard humidity. Standard humidity is the humidity determined by operation mode and set temperature. ("STD" is displayed on the LCD.)
- When the preset humidity is "MOISTURISING", humidity is constantly controlled on a higher level. ("☺" is displayed on the LCD.)
- In COOLING and HEATING operations, the humidity is not controlled.

Example (for 6 hours of sleep)

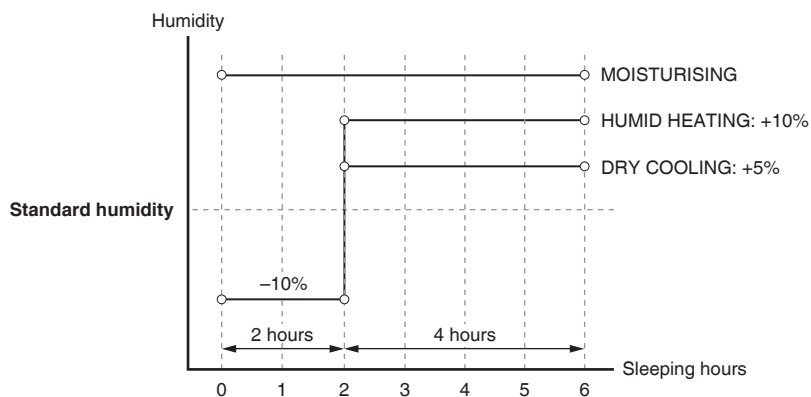

To guarantee high heating capacity when you wake up

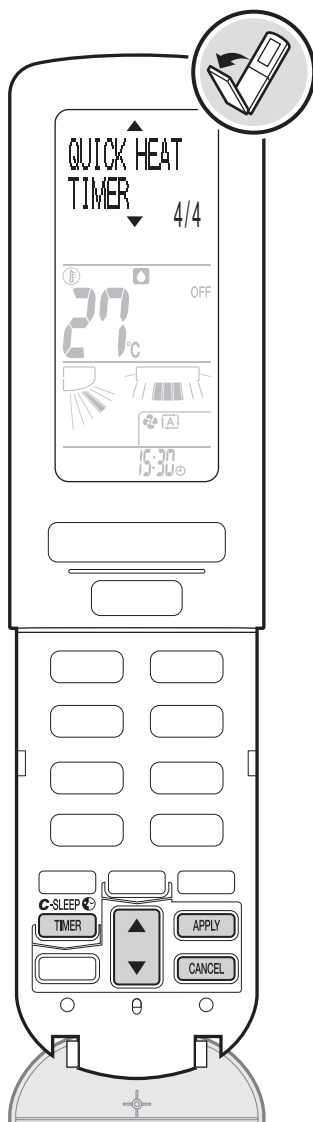

QUICK HEATING TIMER operation

This operation quickly blows warm air when the HEATING operation starts in the morning and makes a warm space (warmth zone) around the indoor unit.

How to set the QUICK HEATING TIMER

1. Press **C-SLEEP TIMER**.

2. Press **▲/▼** to select the item and press **APPLY**.



3. Press **▲/▼** to set the QUICK HEATING time and press **APPLY**.

- Each time you press **▲/▼**, the time changes by 10 minutes. If you press and hold the button, the time changes continuously.
- QUICK HEATING TIMER is set.
- The QUICK HEATING TIMER lamp (dark red) lights up.



4. Press **OFF** to stop the operation.

When the operation stops, defrosting operation automatically starts. (night defrosting)

What happens in the morning?

The air conditioner starts warming up about 30 minutes before the set QUICK HEATING time. (preparatory heating operation)

The QUICK HEATING TIMER lamp (dark red) becomes brighter for a duration of about 30 minutes before and after the set QUICK HEATING time.

5. Confirm that the QUICK HEATING TIMER lamp (bright red) is illuminating and then press **HEAT**.

- The QUICK HEATING TIMER operation is performed for about 30 minutes.
- The OPERATION lamp (green) lights up.
- If **HEAT** is not pressed, the preparatory heating operation will stop after about 30 minutes of QUICK HEATING time.



About 30 minutes later, the air conditioner starts the normal HEATING operation.

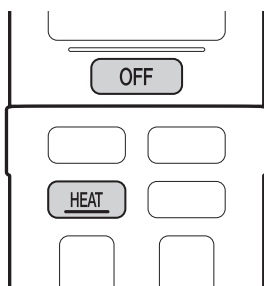



< To change or cancel the setting >

1. Follow steps 1 and 2 on page 21 and then select the timer setting you want to change.

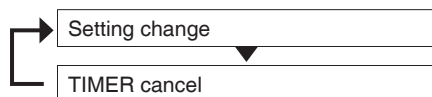
2. Press  to select the item and press .



- Settings can be cancelled with .
- If you cancel the QUICK HEATING TIMER operation halfway through, the operation goes back to the normal HEATING operation. Pressing  also goes back to the normal HEATING operation.





< To stop the operation >

Press .

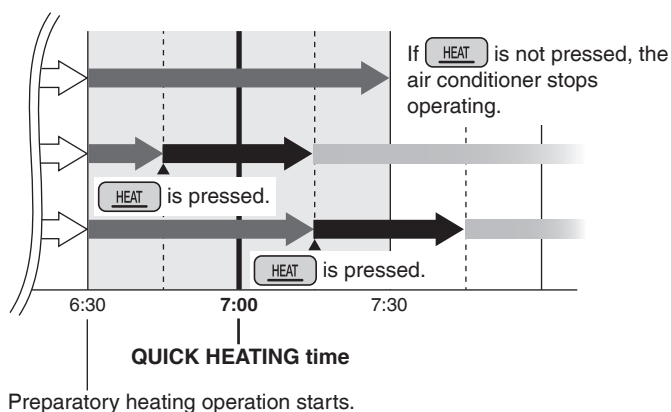
Example

QUICK HEATING time is set to 7:00.



	QUICK HEATING TIMER is set. (QUICK HEATING TIMER lamp (dark red) lights up.)
	Preparatory heating operation is running. (QUICK HEATING TIMER lamp (bright red) lights up.)
	QUICK HEATING TIMER operation is running. (QUICK HEATING TIMER lamp (bright red) and OPERATION lamp (green) light up.)
	Normal HEATING operation is running. (OPERATION lamp (green) lights up.)

Notes on warmth zone

- By blowing warmer air than the normal setting at a lower airflow rate, a warmth zone is created around the indoor unit.
- This function is effective within about 1.5m or less from the wall where the indoor unit is installed.

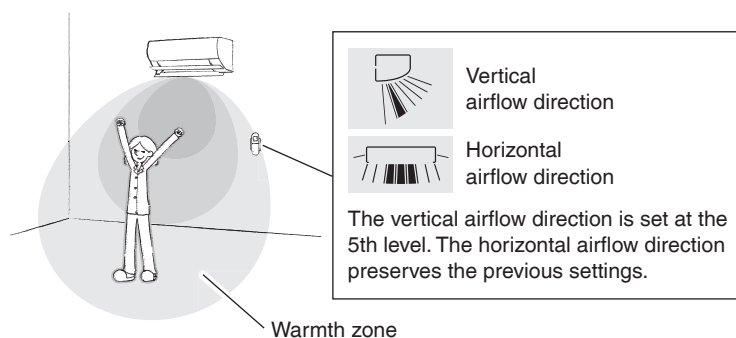

Notes on QUICK HEATING TIMER operation

- To blow warm air quickly, preparatory heating operation is performed for about 30 minutes before and after the set QUICK HEATING time. In this step, electric power is consumed.
- During the preparatory heating operation the flaps open and the fan starts rotating. Also warm air may be blown.
- If you go out and do not use the air conditioner for a long time, cancel the QUICK HEATING TIMER.
- Warm air may be blown at a later stage just after the QUICK HEATING TIMER lamp becomes red or when the protection control works.
- When the indoor temperature is 20°C or higher, or when the outdoor temperature is 16°C or higher, the preparatory heating operation does not start.
- "URURU" HUMIDIFY operation is not performed while the QUICK HEATING TIMER operation is performed.

To increase the cooling or heating power

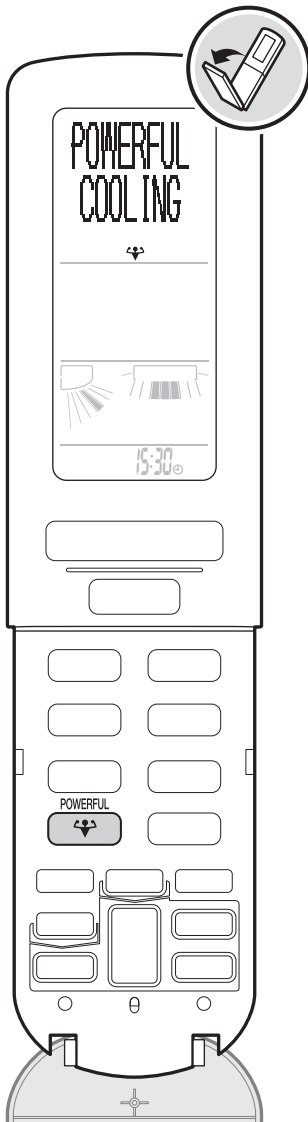

POWERFUL operation

POWERFUL operation quickly maximises the cooling/heating effect. You can get the maximum capacity.

< To use the operation >

Press  during COOLING or HEATING operation.

- When POWERFUL operation is set, the operation mode will be changed as follows.



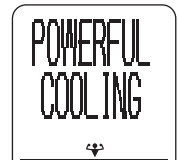

COOLING / DRY COOLING	▶	POWERFUL COOLING (set temperature 18°C)
HEATING / HUMID HEATING	▶	POWERFUL HEATING (set temperature 30°C)

- “” is displayed on the LCD.
- POWERFUL operation ends in 20 minutes. Then the system automatically operates again with the previous settings which were used before POWERFUL operation.
- Temperature and airflow rate cannot be changed.



< To cancel the operation >

Press  again.

- “” disappears from the LCD.
- The operation mode returns to the previous setting.
- POWERFUL operation is cancelled when  , the direct operation buttons,  , or  is pressed.

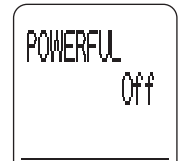

Notes on POWERFUL operation

- The unit's operating sound becomes louder during operation.
- You may not feel sufficient warmth for a while after the operation starts because this operation supplies a higher airflow rate than the normal HEATING operation and the blown air temperature may be lower.
- When using POWERFUL operation, there are some functions which are not available.
- POWERFUL operation will not increase the capacity of the air conditioner if the air conditioner is already in operation with its maximum capacity demonstrated.
- To maximize the cooling/heating effect, the capacity of outdoor unit is increased and the airflow rate is fixed to the maximum setting.

To purify the air in the room

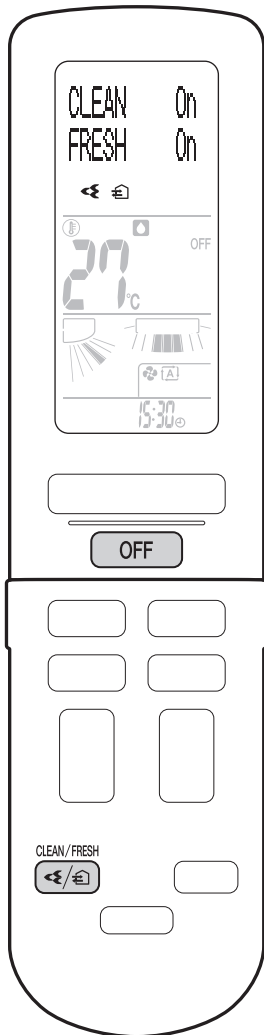

FLASH STREAMER AIR PURIFYING operation

Flash streamer discharge decomposes allergenic substances to clean the air in the room.



FRESH AIR SUPPLY VENTILATION operation

The air in the room is cleaned, taking in fresh air from outside.



< To use the operation >

Press  .

- Each time you press the button, the setting changes.



*1 Ventilation is performed at an automatically adjusted airflow rate.

*2 Ventilation is performed at a high airflow rate.



- “”, “HI”, or “” is displayed on the LCD.
(These symbols are not displayed while the unit is not operating.)

< To stop the operation >

Press  .

< To cancel the setting >

Press  and select “Off”.

- “”, “HI”, or “” disappears from the LCD.
- The operation mode returns to the previous setting.

Note on FLASH STREAMER AIR PURIFYING operation

- When the airflow becomes weak during operation, the streamer discharge may stop temporarily to prevent a small amount of ozone smell coming from the air outlet.

Notes on FRESH AIR SUPPLY VENTILATION operation

- Sounds from outdoors may be heard or odours may be taken in. Also, the unit's operating sound becomes a little louder.
- The unit's operating sound may be different depending on the outdoor temperature and humidity.

To consider the environment of use

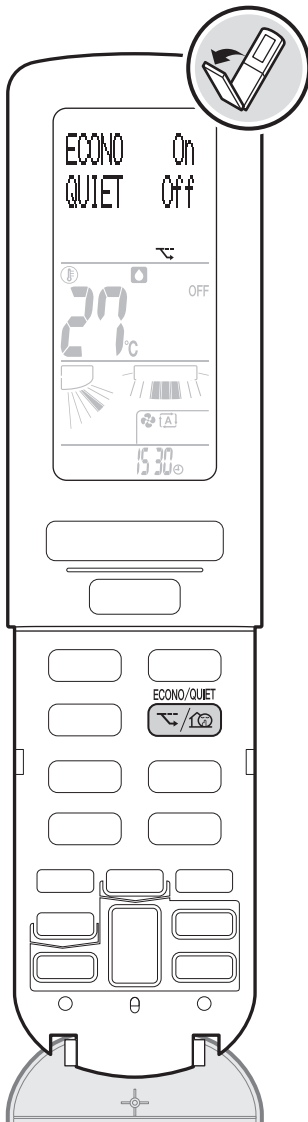

ECONO operation

ECONO operation enables efficient operation by limiting the maximum power consumption value. This function is useful for ensuring a circuit breaker does not trip when the unit runs alongside other appliances.

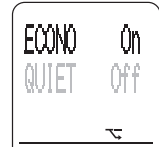

OUTDOOR UNIT QUIET operation

OUTDOOR UNIT QUIET operation lowers the noise level of the outdoor unit by changing the frequency and fan speed on the outdoor unit. This function is useful when you need to consider minimizing noise in your neighbourhood, such as during the night.



< To use the operation >

Press  during operation and select the setting of your preference.

- Each time you press the button, the setting changes.

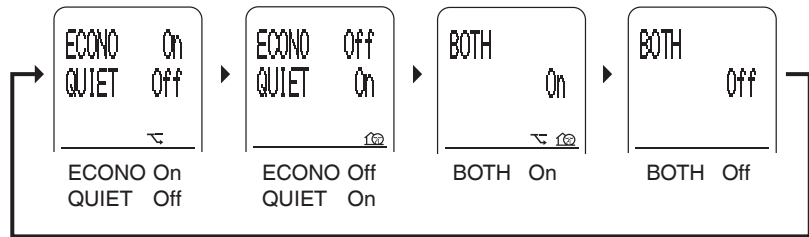

- “”, “”, or “” is displayed on the LCD.

< To cancel the operation >

Press  and select “Off”.

- “”, “”, or “” disappears from the LCD.

Notes on the settings of ECONO and OUTDOOR UNIT QUIET in each operation mode

Mode	ECONO	OUTDOOR UNIT QUIET
AUTO / COOLING / DRY COOLING / HEATING / HUMID HEATING	✓	✓
“SARARA” DRY	✓	–
“URURU” HUMIDIFY / FAN ONLY	–	–

Notes on ECONO operation

< Image of running current and power consumption in ECONO operation >

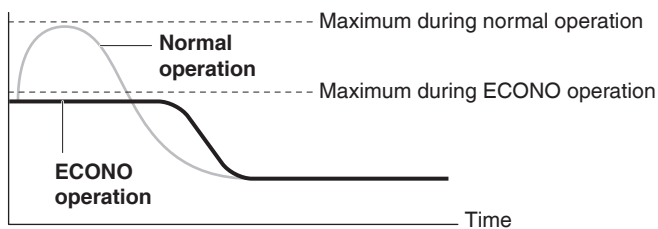

From start up until set temperature is reached

The maximum running current and power consumption of the air conditioner in ECONO operation vary with the connecting outdoor unit.

- Pressing **OFF** causes the settings to be cancelled, and “” disappears from the LCD.
- If the level of power consumption is already low, ECONO operation will not lower the power consumption.
- POWERFUL and ECONO operation cannot be used at the same time. Priority is given to the function of whichever button is pressed last.

Notes on OUTDOOR UNIT QUIET operation

- POWERFUL operation and OUTDOOR UNIT QUIET operation cannot be used at the same time. Priority is given to the function of whichever button is pressed last.
- Even when operation is stopped with **OFF** or indoor unit ON/OFF switch, “” will remain on the remote controller display unless the settings are cancelled.
- OUTDOOR UNIT QUIET operation will lower neither the frequency nor fan speed if they have already been lowered enough.

To keep the air conditioner clean

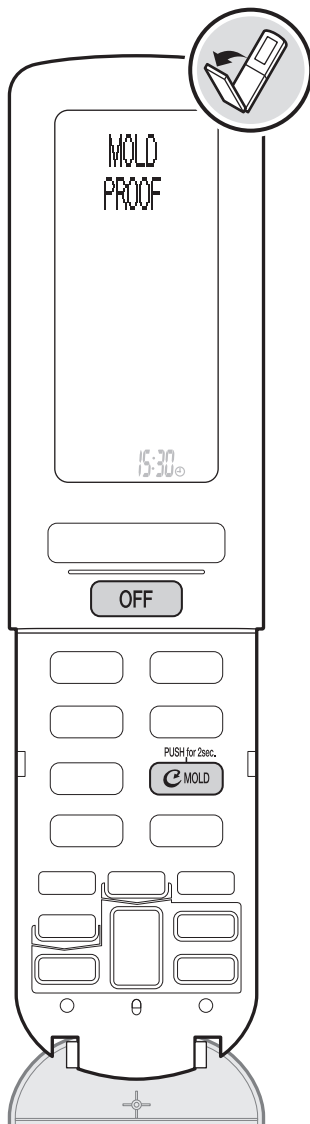

MOLD PROOF / CLEANING FILTER lamp (green)

Ⓢ MOLD PROOF operation

The inside of the air conditioner is dried to reduce the occurrence of mold and odour. When COOLING, "SARARA" DRY, or DRY COOLING operation is performed, condensation may occur inside the air conditioner and may cause mold or odour. It is recommended to dry the inside of the air conditioner by MOLD PROOF operation.

< To automatically operate: Default "Off" >

➤ Press  for about 2 seconds during operation.

- "Ⓢ" is displayed on the LCD.
- MOLD PROOF operation automatically dries the inside of the air conditioner each time after the COOLING, "SARARA" DRY, or DRY COOLING operation is stopped.
- The MOLD PROOF / CLEANING FILTER lamp (green) lights up.
- The operation stops automatically in 100 minutes.

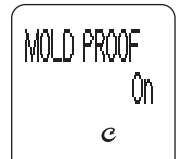

< To cancel the setting >

➤ Press  again for about 2 seconds.

- "Ⓢ" disappears from the LCD.

< To manually operate >

➤ Press  for about 2 seconds while the unit is not operating.

- "MOLD PROOF" is displayed on the LCD, and the display returns to normal after a while.
- The MOLD PROOF / CLEANING FILTER lamp (green) lights up during the operation.
- The operation stops automatically in 100 minutes.



< To cancel the operation halfway through >

➤ Press .

- The MOLD PROOF / CLEANING FILTER lamp goes out.

Notes on automatic operation



■ COOLING / "SARARA" DRY / DRY COOLING operation is running.

■ MOLD PROOF operation is running.

- After COOLING, "SARARA" DRY, or DRY COOLING operation stops, the air conditioner starts the MOLD PROOF operation automatically, and then stops automatically in 100 minutes.
- Even when COOLING is selected in the AUTO operation, the AUTO MOLD PROOF operation is started when the AUTO operation is stopped.
- If the operation is turned off by COUNTDOWN OFF TIMER or OFF TIMER, AUTO MOLD PROOF is not performed.

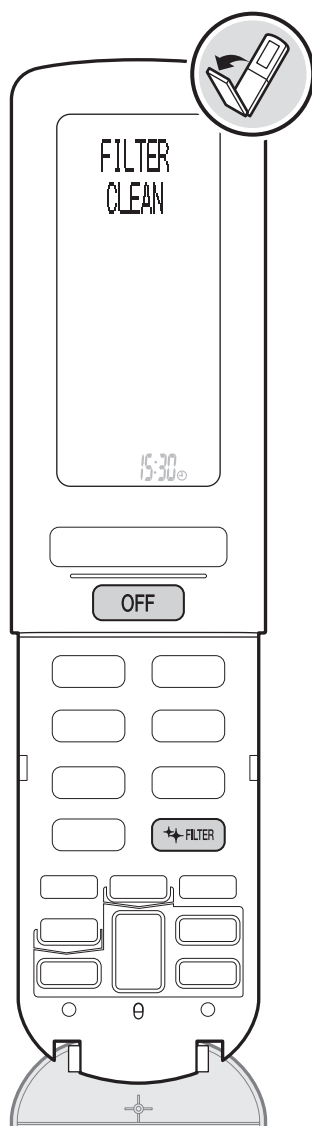

MOLD PROOF / CLEANING FILTER lamp (green)

CLEANING FILTER operation

The air filter will automatically be cleaned.

< To automatically operate: Default “On” >

Press  **during operation.**

- “” is displayed on the LCD.
- The air filter will automatically be cleaned according to the operating hours (about once per day).
- The CLEANING FILTER operation time is a maximum of 11 minutes.
- The MOLD PROOF / CLEANING FILTER lamp (green) lights up during the operation.



< To cancel the setting >

Press  **again.**

- “” disappears from the LCD.

< To manually operate >

Press  **while the unit is not operating.**

- “FILTER CLEAN” is displayed on the LCD, and the display returns to normal after a while.
- The MOLD PROOF / CLEANING FILTER lamp (green) lights up during the operation.



< To cancel the operation halfway through >

Press  **.**

- The MOLD PROOF / CLEANING FILTER lamp goes out.

Notes on automatic operation

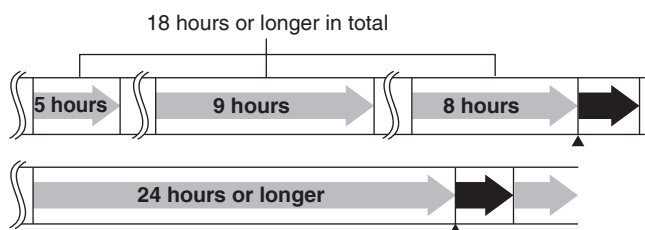

 Air conditioner is operating.

 CLEANING FILTER operation is running.

- CLEANING FILTER operation starts when you stop the unit after operating it for about 18 hours or longer.
- After the air conditioner has continued to operate for 24 hours or longer, the operation is suspended and the CLEANING FILTER operation is started. After cleaning is completed, the air conditioner restarts (including 24 HOUR FRESH AIR SUPPLY VENTILATION).

 Page 34

To keep the air conditioner clean

Notes on MOLD PROOF operation

- This operation dries the inside of the air conditioner with the FAN ONLY and HEATING operation.
- This operation dries the inside of the air conditioner while streamer discharge is performed to reduce the development of odour inside the air conditioner. But the function does not remove any adhered dust and mold.
- The HEATING operation will not start when the outdoor temperature is 24°C or higher or the indoor temperature is higher.
- The flaps may sometimes close to increase the drying effect inside the air conditioner.
- **When the MOLD PROOF / CLEANING FILTER lamp blinks, clean the dust box and reset the dust box cleaning indicator.**

▶ Page 37

Notes on CLEANING FILTER operation

- In this operation, dust is collected in the dust box.
- In an environment where oil or nicotine is attached to the air filter, the filter may not be completely cleaned by the CLEANING FILTER operation, and you may need to clean the air filter by yourself.
- You can remove the air filters and clean them manually as well. ▶ Page 38
- When the indoor temperature is lower than 10°C, the CLEANING FILTER operation will not start to protect the air filters.
- The CLEANING FILTER operation after the "URURU" HUMIDIFY, HUMID HEATING, or FRESH AIR SUPPLY VENTILATION operation may become longer than usual to protect the air conditioner.
- If the AUTO CLEANING FILTER is set to "Off", **the filter may not be completely cleaned unless you perform the CLEANING FILTER operation on a daily basis.**
- **When the MOLD PROOF / CLEANING FILTER lamp blinks, clean the dust box and reset the dust box cleaning indicator.**

▶ Page 37

< Relation between CLEANING FILTER operation and the indoor unit lamp >

Air conditioner	CLEANING FILTER operation	MOLD PROOF / CLEANING FILTER lamp
Operating	Automatic "On"	Goes out *1 *2
	Automatic "Off"	Goes out *2
Not operating	Automatic "On", operating	Lights up
	Automatic "Off", operating	Lights up
	Automatic "On / Off", not operating	Goes out

*1 When AUTO CLEANING FILTER operation is started after the unit has continued to operate for 24 hours or longer, the MOLD PROOF / CLEANING FILTER lamp will light up.

*2 If the AUTO MOLD PROOF is set to "On", the lamp will light up.

To know the status of your room and air conditioner

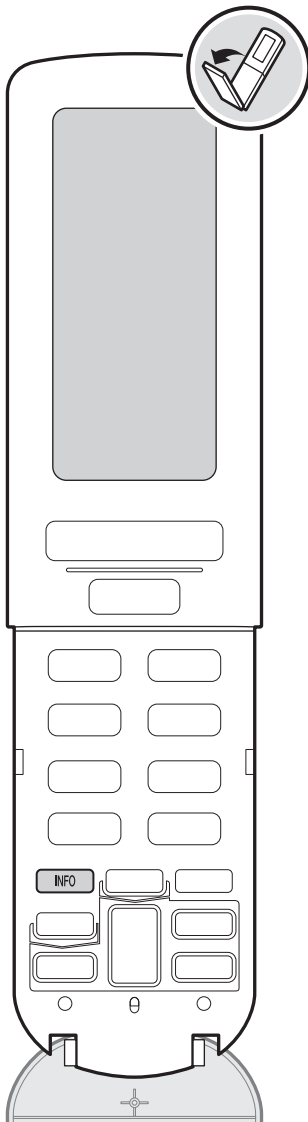

INFORMATION

The indicator displayed on the LCD gives information about temperature, power consumption, and so on.
 The indicated indoor and outdoor temperatures are measured near the indoor and outdoor units.
 The indicator should be used as a guide only.

< To see the information >

➤ **Direct the remote controller toward the indoor unit and press **INFO**.**

- Keep directing the remote controller toward the indoor unit for about 2 seconds.
A signal is received from the indoor unit.
- Each time you press the button, the information changes.

LCD example

When the indoor temperature is 30°C during DRY COOLING operation.

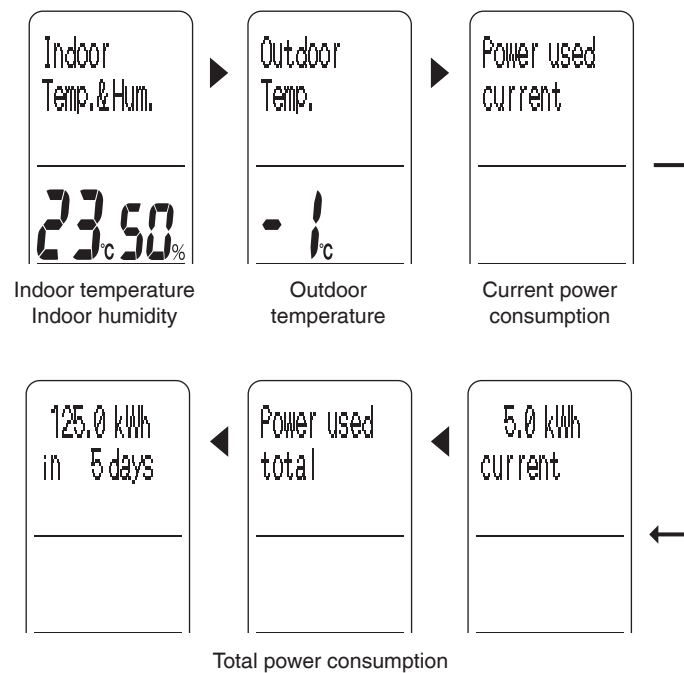

Notes on INFORMATION

- The total power consumption is displayed up to 9,999kWh. When the total power consumption exceeds 9,999kWh, the indicator shows 0kWh. Also, if the total number of days that the unit is used exceeds 999, the indicator shows 0 days. (The displayed number of days is the total time that the power to the unit is on.) Please use these indications as a guide.
- The power consumption is displayed in increments of 0.1kWh up to 50kWh and in increments of 1kWh after 50kWh.
- The indoor and outdoor temperatures are indicated by estimating the temperatures near the indoor and outdoor units based on the temperatures detected by the sensor attached to the indoor and outdoor units.
- If the signals from the remote controller do not properly reach the indoor unit, the setting displayed on the LCD may be different from the actual operation of the indoor unit. If you press **INFO** in that condition, the operation of the indoor unit will be changed according to the setting on the remote controller.
- If **INFO** is pressed when the outdoor temperature cannot be detected such as when the unit is stopped, the outdoor temperature is displayed as "--". In this case, press **INFO** again.
- Indoor and outdoor temperatures between -9°C and 39°C can be displayed.

To change the default settings

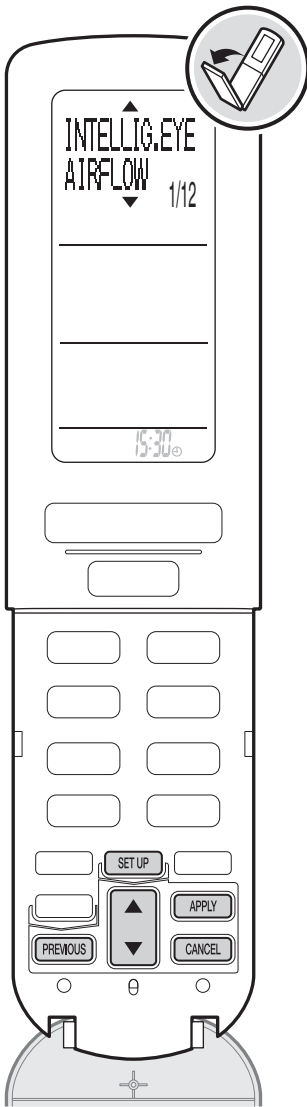

Menu settings

You can change the default settings according to your room's environment and your taste.

< To change the setting >

Press **SET UP**.

Press **▲** to select the item and press **APPLY**.

No.	Menu items	Page
1	INTELLIG.EYE AIRFLOW	32
2	AUTO OFF time	32
3	BREEZE AIRFLOW	32
4	HUMIDIFY AIRFLOW	32
5	CONTINUE DRY	33
6	INSTALLED POSITION	33
7	RESET USED POWER	33
8	SOUND VOLUME	33
9	CONTRAST	34
10	24 HOUR FRESH AIR	34
11	RC ADDRESS	34
12	CHILD LOCK	34

Press **▲** to select each setting and press **APPLY**.

- To set 24 HOUR FRESH AIR, RC ADDRESS, or CHILD LOCK, press for about 2 seconds.
- When the setting is completed, the menu screen is displayed again (except when setting CHILD LOCK).
- The menu screen will return to the original screen if no operation is made for about 1 minute.

< To return to the previous display >

Press **PREVIOUS**.

< To exit the menu settings >

Press **CANCEL**.

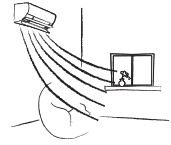
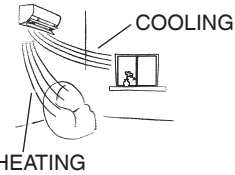
No.	Menu	Setting	Description
1	INTELLIG.EYE AIRFLOW	Focus	The INTELLIGENT EYE sensor detects an area where there is a person and adjusts the horizontal airflow direction to blow air directly on the person.
		Comfort *	The INTELLIGENT EYE sensor detects an area where there is a person and adjusts the horizontal airflow direction to avoid blowing air directly on the person.
<p>< Note ></p> <p>■ Focus</p> <ul style="list-style-type: none"> The vertical airflow direction is adjusted so that the maximum airflow rate is achieved. <p>■ Comfort</p> <ul style="list-style-type: none"> The unit blows air upward in the COOLING operation and downward in the HEATING operation. <div style="text-align: right;">   </div>			
2	AUTO OFF time	1 HR *	<p>Sets the time for stopping the operation to after 1 hour or after 3 hours.</p> <ul style="list-style-type: none"> This function is not activated during the following operations. <div style="border: 1px solid black; padding: 5px; width: fit-content; margin: 5px auto;"> MOLD PROOF, QUICK HEATING TIMER and CLEANING FILTER operation </div> <p>This function will be activated after the end of each operation.</p>
		3 HR	<ul style="list-style-type: none"> This function is not totally activated if the 24 HOUR FRESH AIR SUPPLY VENTILATION is set.
<p>< Note ></p> <ul style="list-style-type: none"> This function changes the set temperature +2°C in COOLING / -2°C in HEATING and the operation stops after the preset time elapses if it is judged that no one is in the room. 3 minutes before the operation stops, the OPERATION lamp blinks to lower the airflow rate. After that, the operation stops. In this mode, the operation stops automatically. It is recommended to set the AUTO OFF operation to "Off" if a small child or a sick person is in the room. (If a person does not move much, the sensor judges that no one is in the room and the air conditioner may be stopped.) If the operation has been stopped by AUTO OFF operation, the LCD will not show "OFF". 			
3	BREEZE AIRFLOW	Auto *	Sets the BREEZE AIRFLOW rate to "Auto".
		Low	Sets the BREEZE AIRFLOW rate to "Low".
<p>< Note ></p> <ul style="list-style-type: none"> This function sets the airflow rate when the vertical airflow direction is set to "BREEZE". If you are disturbed by the unit's operating sound, set it to "Low". 			
4	HUMIDIFY AIRFLOW	Auto *	Sets the humidified airflow rate to "Auto".
		High	Sets the humidified airflow rate to "High".
		Low	Sets the humidified airflow rate to "Low".
<p>< Note ></p> <ul style="list-style-type: none"> This function sets the humidified airflow rate in the "URURU" HUMIDIFY and HUMID HEATING operations. To increase the humidified airflow rate, set it to "High" and if you are disturbed by the sound of the humidifying operation, set it to "Low". 			







* Default setting

To change the default settings

No.	Menu	Setting	Description
5	CONTINUE DRY	On *	CONTINUE DRY operation is performed.
		Off	CONTINUE DRY operation is not performed.

< Note >

- When the indoor temperature or humidity falls far below the preset value, the fans of indoor and outdoor units are stopped to keep the room comfortable. This operation is activated in the COOLING, "SARARA" DRY, and DRY COOLING operations.
- When the CONTINUE DRY is set to "On", starting the COOLING, "SARARA" DRY, or DRY COOLING operation triggers the deodorising function which reduces any unpleasant odour coming from the indoor unit and the unit does not blow air for 40 seconds.
- Before the outdoor unit operates, the indoor temperature may be higher than the set temperature.

6	INSTALLED POSITION	 *	Oblong centre * The horizontal airflow direction blows air evenly to the right and left.
			Oblong right corner The horizontal airflow direction blows air to the left.
			Oblong left corner The horizontal airflow direction blows air to the right.
			Horizontal centre The horizontal airflow direction blows air evenly to the right and left.
			Horizontal right corner The horizontal airflow direction blows air to the left.
			Horizontal left corner The horizontal airflow direction blows air to the right.

< Note >

- Airflow direction is properly controlled by inputting data on the room shape and installation position of the indoor unit in the remote controller. Set oblong or horizontal according to the room shape.
- If you do not set the right corner and left corner correctly, the airflow direction may not be properly controlled in some airflow settings.
- The airflow direction range at the horizontal airflow setting (airflow direction that can be selected with ) will change according to the settings for the installation position.

< Setting guides >

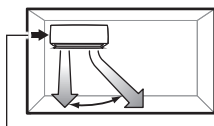

When the distance is 2 to 50cm, set to the left corner.

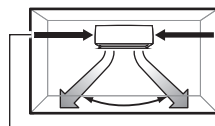

When the unit is installed in the centre, set to centre.

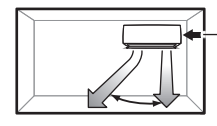

When the distance is 2 to 50cm, set to the right corner.

7	RESET USED POWER	Reset with APPLY	Resets the total power consumption to 0kWh.
---	------------------	------------------	---

< Note >

- This function resets the total power consumption.
- To check the power consumption, press .

8	SOUND VOLUME	High	The volume is high.
		Low *	Normal volume.
		Off	The volume is off.

< Note >

- This function sets the volume of the receiving tone of the indoor unit.

* Default setting

No.	Menu	Setting	Description
9	CONTRAST	1 to 5	<ul style="list-style-type: none"> You can set the contrast between 1 and 5. The default setting is "3". The higher the figure, the darker the indicator.

< Note >

- This function sets the contrast of the LCD.

10	24 HOUR FRESH AIR	Push APPLY 2sec. On	Starts 24 HOUR FRESH AIR SUPPLY VENTILATION operation.
		Push APPLY 2sec. Off *	Stops 24 HOUR FRESH AIR SUPPLY VENTILATION operation.

< Note >

- Even if you stop the air conditioner with the remote controller, it continues ventilation for 24 hours until you change the setting to "Off".
- The 24 HOUR FRESH AIR SUPPLY VENTILATION starts itself when the circuit breaker has been turned on. (The OPERATION lamp of the unit is off during the operation. No display is shown on the remote controller.)
- When the 24 HOUR FRESH AIR SUPPLY VENTILATION is solely operated, the streamer discharge cannot be started.
- When the AUTO CLEANING FILTER is set to "On" and the normal operation of the air conditioner stops for 24 hours or longer, the 24 HOUR FRESH AIR SUPPLY VENTILATION is terminated and the CLEANING FILTER operation starts (and lasts for about 11 minutes). After the filter has been cleaned, the 24 HOUR FRESH AIR SUPPLY VENTILATION restarts. ▶ Page 28

11	RC ADDRESS	Push APPLY 2sec. 1 *	<p>The default setting is "1" for both the indoor unit and remote controller.</p> <p>< To set the address to "2" ></p> <ol style="list-style-type: none"> Open the front panel, and turn on the circuit breaker. Press SETUP. Press ▲ to select "RC ADDRESS" and press APPLY. Press ▲ to select "2". Press APPLY for 2 seconds and send a signal to the indoor unit. The OPERATION lamp (green) blinks for about 1 minute. (This is not an error blink.) Press the indoor unit ON/OFF switch while the OPERATION lamp is blinking.
		Push APPLY 2sec. 2	

< Note >

- This function sets the address when you install 2 indoor units in the same room and do not want to operate them with 1 remote controller. When you set one of the indoor units and one of the 2 remote controllers to "2", the set remote controller can send a signal only to the set indoor unit.

12	CHILD LOCK	Push APPLY 2sec. On	Press APPLY for about 2 seconds to activate the child lock function.
		Push APPLY 2sec. Off	Press APPLY for about 2 seconds to cancel the child lock function.

< Note >

- This function prevents children from operating the remote controller by mistake.



is displayed and the buttons except **SETUP** is disabled.

* Default setting

Cleaning (for service personnel)

CAUTION

- Be sure to stop the operation and turn off the circuit breaker before cleaning.
- For care and cleaning, call service personnel.

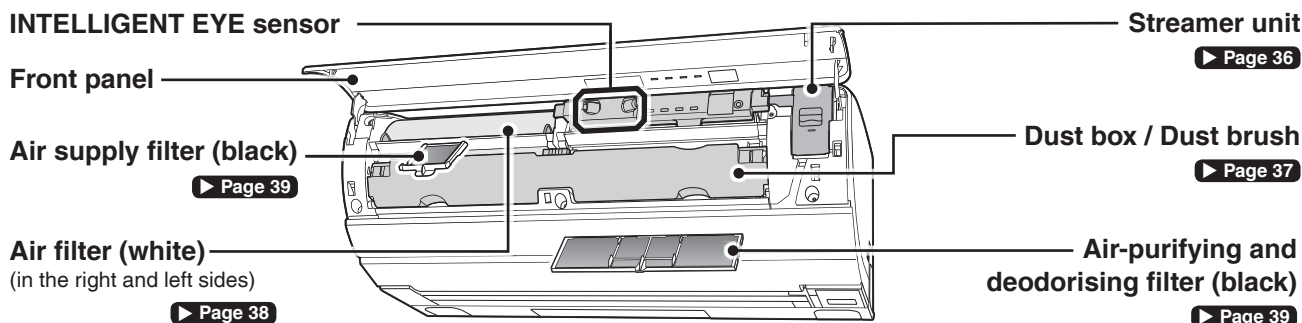

Front panel

When?

When you find dirt or dust.

How?

- Wipe gently with a soft cloth moistened with water or neutral liquid detergent.
- Make sure to clean the back of the front panel.

CAUTION

- When removing and attaching the front panel, stand on a solid, stable base and take care not to fall.
- When removing and attaching the front panel, support the panel securely with your hands to prevent it from falling.

Removing the front panel

1. Turn off the circuit breaker.
2. Hold the panel at both ends and open until the panel stops.

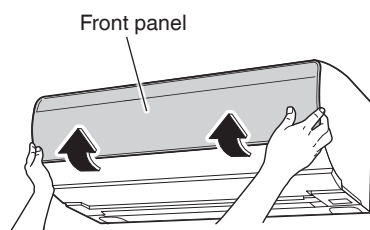

- Pushing further up from the stopping position allows the panel to be removed more easily.

3. Remove the front panel.

- While pushing the left-side front panel shaft outward, push up the front panel and remove it. (Remove the right-side front panel shaft in the same manner.)
- After removing both front panel shafts, pull the front panel toward yourself and remove it.

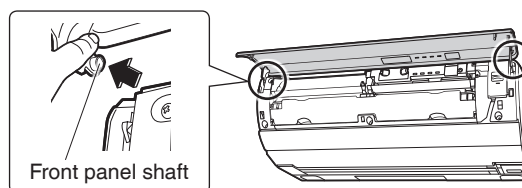

Attaching the front panel

1. Insert the right and left front panel shafts on the front panel into the shaft holes one at a time.

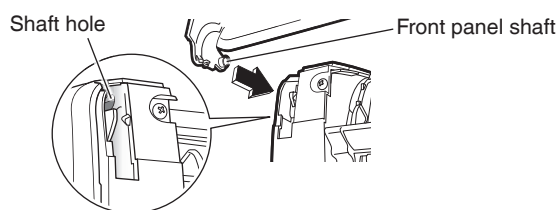

2. Close the front panel slowly and press on both sides of the front panel.

Confirm that the front panel is securely installed.

Indoor unit / INTELLIGENT EYE sensor

When?

When you find dirt or dust.

How?

- Wipe gently with a soft, dry cloth.
- Make sure to clean the lens part of the INTELLIGENT EYE sensor.

CAUTION

- Do not touch the aluminium fins of the indoor unit. (It may cause an injury.)
- Do not use the following to clean the air conditioner. (It may cause deformation, discolouration or scratches.)
 - Water hotter than 40°C
 - Volatile liquid such as benzene, petrol and thinner
 - Polishing compound
 - Rough materials such as scrubbing brush

Streamer unit

When?

When the **TIMER lamp (orange)** blinks or once in a season.

The **TIMER lamp** blinks to indicate that the streamer unit needs cleaning when the total operation time of the air conditioner exceeds 1,800 hours. (**Streamer unit cleaning indicator**) Clean the streamer unit.

Streamer discharge is disabled while the lamp is blinking.

How?

- 1) Soak the streamer unit in lukewarm water or cold water (for about 1 hour).
- 2) Use a cotton bud or soft cloth to clean the unit. (**Wear rubber gloves.**)
- 3) Wash the unit with running water and drain it thoroughly.
- 4) Dry the unit in a well-ventilated shady area (for about 1 day).

Reset the indicator after cleaning.

Turn on the circuit breaker, and press **RESET** and then **APPLY** while the air conditioner is not operating. **▶ Page 8**

- The streamer unit cleaning indicator goes out.

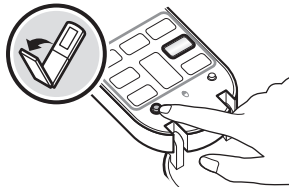

If dust adheres to the needles

Gently wipe the dust from the needles with a soft material such as a cotton bud, moistened with water or neutral liquid detergent. When wiping dust off, be careful not to deform the needles. A deformed needle will lower the deodorisation ability.

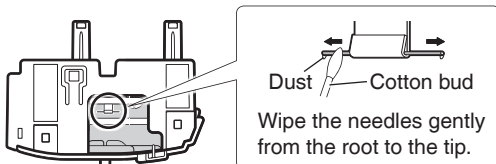

Removing the streamer unit

- **Hold the grip of the streamer unit and pull it toward yourself.**

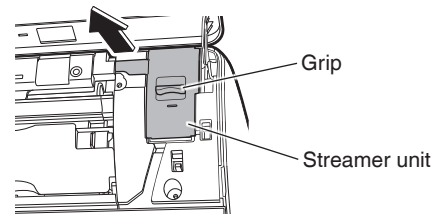

Attaching the streamer unit

- **Insert the streamer unit all the way in.**

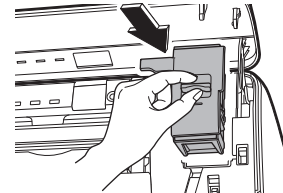

Attention

- If you cannot remove dirt or dust completely, add neutral liquid detergent to lukewarm water or cold water and soak the filter in it.
- Follow the instructions regarding neutral liquid detergent when you use it. Wash the streamer unit thoroughly with water after using detergent to remove any residue.
- Be careful not to leave any lint on the streamer unit. (Lint may cause the unit to malfunction.)
- Do not disassemble the streamer unit.

Cleaning (for service personnel)

Dust box / Dust brush

When?

When the **MOLD PROOF / CLEANING FILTER lamp (green)** blinks.

The MOLD PROOF / CLEANING FILTER lamp blinks to indicate that the dust box needs cleaning when there is dust in the dust box or when the dust brush gets dirty with the CLEANING FILTER operation (automatic or manual). (**Dust box cleaning indicator**) Clean the dust box. CLEANING FILTER operation cannot be performed while the lamp is blinking.

How?

- Use a vacuum cleaner to remove dust or wash with water.
- If you have washed the dust box with water, dry it well in the shade.

Reset the indicator after cleaning.

Turn on the circuit breaker, and press **RESET** and then **APPLY** while the air conditioner is not operating. ▶ **Page 8**

- The dust box cleaning indicator goes out.

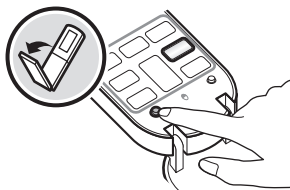

Removing the dust box

1. Slide the right and left fixing tabs (blue) inwards and slowly pull the dust box out with both hands.

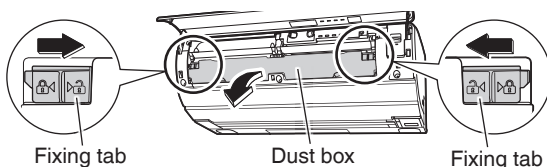

2. Open the dust box.

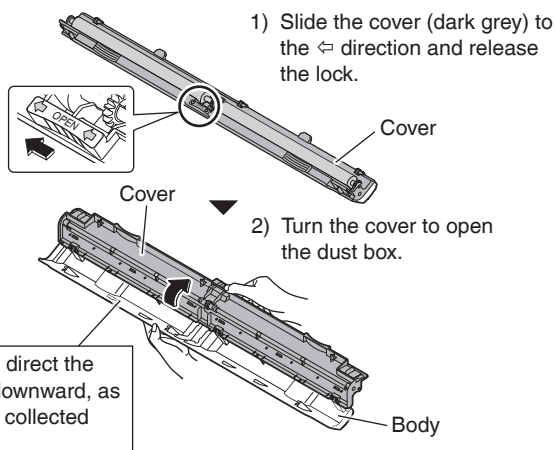

< Removing or attaching the dust brush >

- 1) Pull the centre of the dust brush.
- 2) Take out the dust brush from the right-side and left-side shaft holes.
- 3) Pull out the dust brush. For installation, attach the dust brush to the shaft holes, and push it in the dust box.

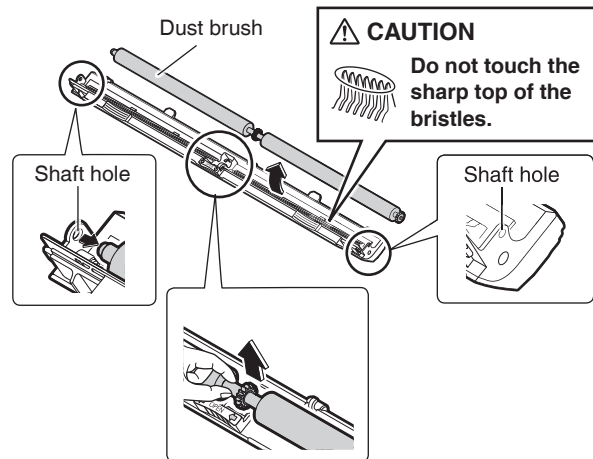

Confirm that the dust brush is securely attached. Otherwise, the dust brush may not rotate and the CLEANING FILTER operation may not be performed.

Attaching the dust box

1. Close the dust box, and then slide the cover to lock the dust box.

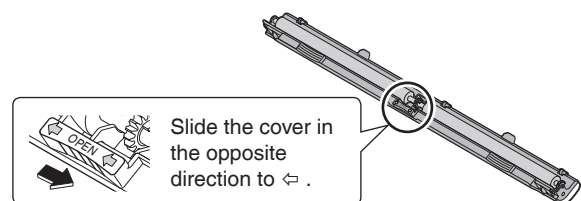

2. Hold the dust box with both hands and attach it in the unit so that the dust brush faces the air conditioner side.

3. Slide the fixing tabs at both ends outwards.

CLEANING FILTER operation will not be correctly performed if the tabs are not securely locked.

When you clean the filters, open the front panel and remove the dust box.

Air filter (white)

If the AUTO CLEANING FILTER operation is set to "On", basically no care is required. ▶ Page 28

When you are aware of dirt, such as when oil or nicotine is attached to the air filter or when the AUTO CLEANING FILTER operation is set to "Off", clean the filter.

When?

When you find dirt or dust.

How?

- Use a vacuum cleaner to remove dust.
- If you cannot remove dirt or dust completely, soak the filter in lukewarm water with neutral liquid detergent and clean with a sponge.
- After washing the filter, drain it.
- Smooth the filter by hand and dry it well in the shade.

Attention

- Do not disassemble the air filter.

Removing the air filter

1. Pull down the filter holding frame (yellow).

- The tabs of the filter holding frame (yellow) are provided one on each side.

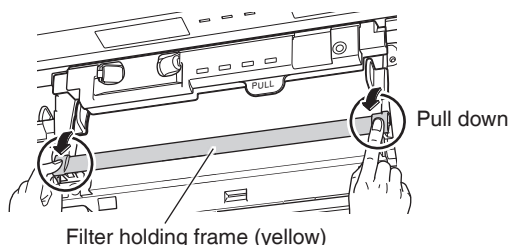

2. Pull out the air filter.

- 1) Hold the PULL tab on the display unit (black), direct the unit upward.
- 2) Raise the grips of the air filter (blue) upward to the front.
- 3) Pull the grips downward.

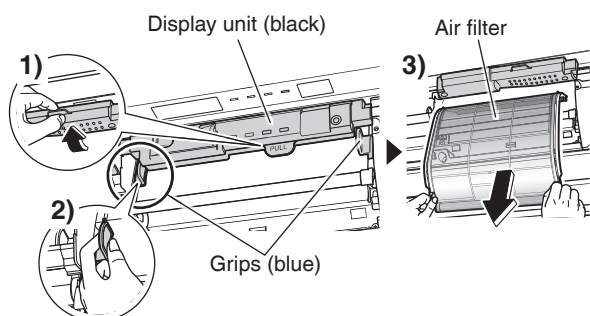

Attaching the air filter

1. Hold the grips (blue) and insert the filter along the rail.

- After attaching the air filter, direct the display unit (black) downward.

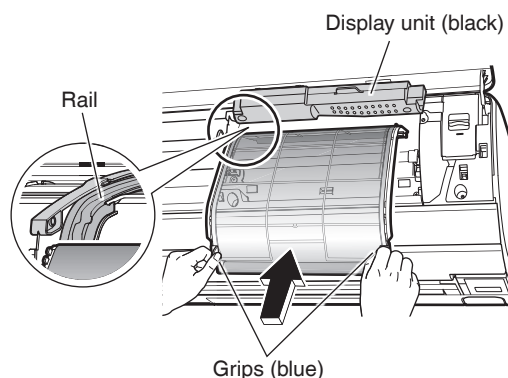

2. Push up the filter holding frame (yellow) until it clicks.

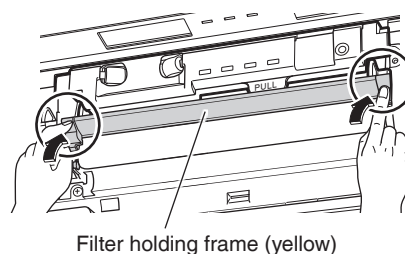

If the frame is not securely locked, the front panel may be damaged.

After cleaning, start the CLEANING FILTER operation to check that the air filter operates correctly. ▶ Page 28

Cleaning (for service personnel)

When you clean the filters, open the front panel and remove the dust box.

Air-purifying and deodorising filter (black)

When?

When you find dust.

How?

- Use a vacuum cleaner to remove dust.

Attention

- Never wash the filter in water.

Removing the air-purifying and deodorising filter

1. Remove the right-side air filter. ▶ Page 38
2. Lift the grip and remove the filter from the tabs.

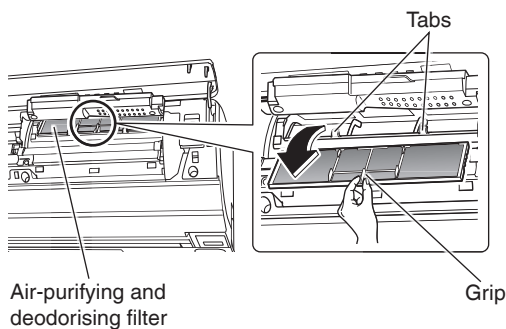

Air-purifying and deodorising filter

Attaching the air-purifying and deodorising filter

Return the air-purifying and deodorising filter to its position.

- Hang the air-purifying and deodorising filter on the tabs of the air conditioner.

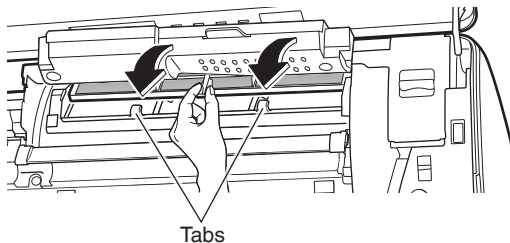

Tabs

CLEANING FILTER operation will not be performed properly if the air-purifying and deodorising filter is not attached correctly.

After cleaning, start the CLEANING FILTER operation to check that the air filter operates correctly. ▶ Page 28

- Dispose of old filters as non-flammable waste.
- To order an air-purifying and deodorising filter, contact the service shop where you bought the air conditioner.

Item	Air-purifying and deodorising filter (with frame) 1 set
Part No.	KAF046A41

Air supply filter (black)

When?

When you find dirt or dust.

How?

- Use a vacuum cleaner to remove dust.
- If you cannot remove dust completely, soak the filter (with the frame) in lukewarm water or cold water for about 10 to 15 minutes and wash it.

Attention

- Do not rub the filter.
- After soaking the air supply filter, drain it and dry it well in the shade.

Removing the air supply filter

1. Remove the left-side air filter. ▶ Page 38
2. Raise the filter holding frame (yellow), hold the grip and pull it to the front.

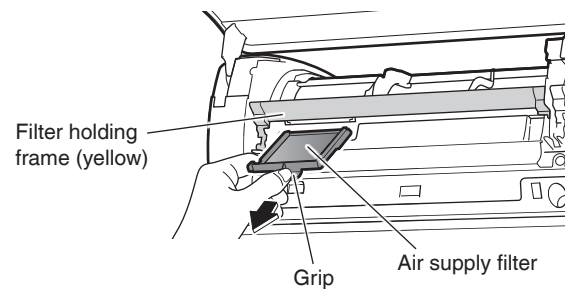

Filter holding frame (yellow)

Grip

Air supply filter

Attaching the air supply filter

Return the air supply filter to its position.

- Direct ▲ on the filter upward and insert the air supply filter until it clicks.

After cleaning, start the CLEANING FILTER operation to check that the air filter operates correctly. ▶ Page 28

When the OPERATION lamp (green) blinks



OPERATION lamp (green)

When the **TIMER lamp (orange)** blinks ▶ Page 36

When the **MOLD PROOF / CLEANING FILTER lamp (green)** blinks ▶ Page 37

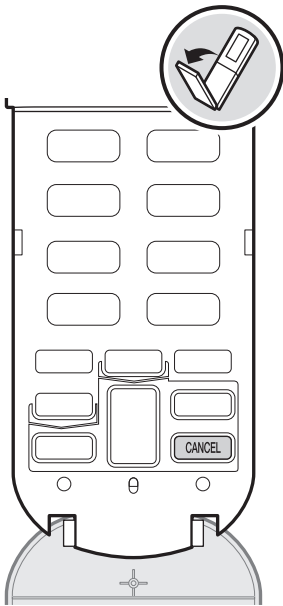

When the OPERATION lamp (green) blinks, turn off the circuit breaker. After about 1 minute, turn it on again and start operation.

If the OPERATION lamp still blinks, check the error code according to the steps below and take appropriate action.

< To check the error code >

1. Direct the remote controller toward the indoor unit and press **CANCEL for about 5 seconds.**

- An error code is displayed on the LCD.

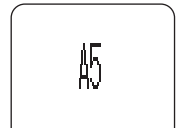

2. Check the error code and take the action described below.

Error code	Check operation and action
A5	Is the air filter soiled or dusty? <ul style="list-style-type: none"> • Stop the operation and start the CLEANING FILTER operation. ▶ Page 28

Turn off the circuit breaker and turn it on again. Then start operation.

E7	Is any foreign object stuck in the outdoor unit fan? <ul style="list-style-type: none"> • Turn off the circuit breaker, and then remove foreign objects.
F3,F6,L3,L4,L5	Is the air outlet of the outdoor unit blocked by a car or the like? <ul style="list-style-type: none"> • Turn off the circuit breaker, and then remove the obstruction.

Turn on the circuit breaker and start operation.

Other error codes	Check the model name (or control code *) and contact the service shop.
-------------------	--

3. Check the OPERATION lamp again and take the action described below.

OPERATION lamp	Action
Lights up	Continue the operation for a while and if the OPERATION lamp does not blink, keep on using the air conditioner.
Blinks again	Check the model name (or control code *) and contact the service shop.

< * To check the control code >

Press **CANCEL again while the error code is displayed on the LCD.**

- A 4-digit control code is displayed on the LCD.
If the model name cannot be checked with the indoor unit, use this control code for the inquiry.

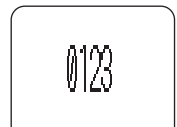

Attention

- When **CANCEL** is pressed for about 5 seconds when the OPERATION lamp is not blinking, "00" is displayed.
- For other possible failures.

▶ Page 41 - 45

The following error code indicates an error of the humidifying unit or some sensors. Only the **COOLING** and **HEATING** operations are available in this case. Contact the service shop as soon as possible.

PH, PA, P9, CC, CA, U7

FAQ

Indoor unit

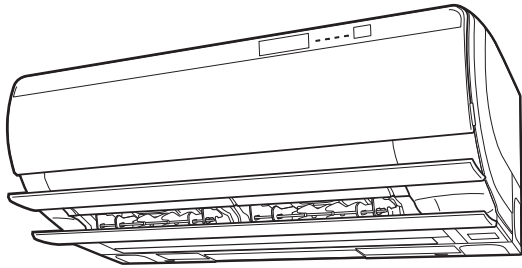

The flaps do not start swing immediately.

- The air conditioner is adjusting the flaps position. The flaps will start moving soon.

The air conditioner stops generating airflow during operation.

- Once the set temperature is reached, the airflow rate is reduced and operation stopped in order to avoid generating cool airflow (during heating) or in order to keep the humidity from rising (during cooling). Operation will resume automatically when the indoor temperature rises or falls.

Operation does not start soon.

- **When AUTO button, direct operation buttons or FAN ONLY button was pressed soon after operation was stopped.**
- **When the mode was reselected.**
 - This is to protect the air conditioner. You should wait for about 3 minutes.

The HEATING operation stops suddenly and a flowing sound is heard.

- The outdoor unit is taking away the frost. The HEATING operation starts after the frost on the outdoor unit is removed. You should wait for about 3 to 10 minutes.

Outdoor unit

The outdoor unit emits water or steam.

- **In HEATING operation**
 - The frost on the outdoor unit melts into water or steam when the air conditioner is in defrost operation.
- **In COOLING or "SARARA" DRY operation**
 - Moisture in the air condenses into water on the cool surface of outdoor unit piping and drips.

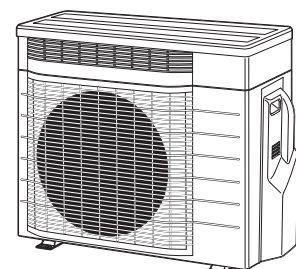

Commonly occurring sounds

■ A hissing sound

- This is a sound generated when humidified air or ventilated air is discharged.
- Operating sound may vary depending on the outdoor temperature or humidity.

■ Roaring sound

- This is a sound of ventilating operation. (When ventilating operation is combined with COOLING/HEATING operation, it is possible to stop only ventilating operation.)

▶ Page 24

■ Hissing or cracking sound

- This is a sound of streamer discharge.

■ Rustling sound

- This is a sound of the dust brush rubbing the air filter to remove dust from the air filter in CLEANING FILTER operation.

■ Clicking sound while the air conditioner is or is not in operation

- This is a sound of operation of the electric components or valve that controls the refrigerant.

■ A sound like a flow of water

- This is a sound of the refrigerant flowing in the air conditioner.
- This is a pumping sound of the water in the air conditioner and heard when the water is pumped out from the air conditioner in cooling or drying operation.

■ Blowing sound

- This is a sound generated when the direction of the flow of the refrigerant changes in the air conditioner.

■ Ticking sound

- This is a sound generated when the air conditioner slightly expands or shrinks due to temperature change.

■ Clopping sound

- This is a sound that comes from the inside of the air conditioner when the ventilating fan is operated with the room closed. This sound may decrease when the window is opened or the ventilating fan is stopped.

■ Whistling sound



- This is a sound generated when the refrigerant flows during defrosting operation.

Troubleshooting (for service personnel)



Before making an inquiry or a request for repair, check the following.
If the problem persists, consult the service shop.

	<p>Not trouble</p> <p>These cases are not troubles.</p>		<p>Check</p> <p>Please check again before calling a repair person.</p>
---	--	---	---



The air conditioner does not operate

Case	Description / where to check
Operation was started during CLEANING FILTER operation.	 <ul style="list-style-type: none"> The air filter is moving back to the normal position. Wait for up to about 3 minutes.
Operation was started immediately after CLEANING FILTER operation stopped.	
The air conditioner does not operate. [OPERATION lamp is off]	 <ul style="list-style-type: none"> Has the circuit breaker been tripped or the fuse blown? Is it power failure? Are batteries set in the remote controller? Does the address of the indoor unit match that of the remote controller? Set the address again. ▶ Page 34
The air conditioner does not operate. [OPERATION lamp is blinking]	 <ul style="list-style-type: none"> Turn off the power with the circuit breaker and restart operation with the remote controller. If the OPERATION lamp is still blinking, check the error code and consult the service shop. ▶ Page 40

The air conditioner stops operating

Case	Description / where to check
Operation stops suddenly. [OPERATION lamp is on]	 <ul style="list-style-type: none"> For system protection, the air conditioner may stop operating on a sudden large voltage fluctuation. It automatically resumes operation in about 3 minutes.
Operation stops suddenly. [OPERATION lamp is blinking]	 <ul style="list-style-type: none"> Is there anything blocking the air inlet or air outlet of the indoor unit or outdoor unit? Stop operation and after turning off the circuit breaker, remove the obstruction. Then restart operation with the remote controller. If the OPERATION lamp is still blinking, check the error code and consult the service shop. ▶ Page 40

The air conditioner does not stop operating

Case	Description / where to check
The air conditioner continues operating even after COOLING, "SARARA" DRY, or DRY COOLING operation is stopped.	 <ul style="list-style-type: none"> This happens when the unit is in AUTO MOLD PROOF operation. When you want to stop MOLD PROOF operation in the middle, press <input type="button" value="OFF"/> . If the AUTO MOLD PROOF operation does not suit your preference, set the operation to "Off". ▶ Page 27
The air conditioner continues operating even after operation is stopped.	 <ul style="list-style-type: none"> <ul style="list-style-type: none"> Immediately after the air conditioner is stopped <ul style="list-style-type: none"> This happens when defrosting operation (night defrosting) is running. (When QUICK HEATING TIMER is set.) ▶ Page 21 The outdoor unit fan continues rotating for another about 1 minute for system protection. While the air conditioner is not in operation <ul style="list-style-type: none"> When the outdoor temperature is high, the outdoor unit fan may start rotating for system protection. When 24 HOUR FRESH AIR SUPPLY VENTILATION is enabled, the air conditioner continuously performs the ventilating operation with the OPERATION lamp off even after another operation is stopped. This happens when preparatory heating operation for QUICK HEATING TIMER is running. ▶ Page 21 This happens when the unit is in CLEANING FILTER operation. Wait for about 11 minutes. ▶ Page 28

Troubleshooting (for service personnel)

The room does not cool down/warm up

Case	Description / where to check
Air does not come out.	<ul style="list-style-type: none"> <input checked="" type="checkbox"/> ■ In HEATING operation <ul style="list-style-type: none"> • The air conditioner is warming up. Wait for about 1 to 4 minutes. ■ In COOLING / "SARARA" DRY / DRY COOLING operation <ul style="list-style-type: none"> • When the airflow rate setting is "AUTO", a function to prevent emission of an odour contained in the indoor unit operates. This keeps air from coming out immediately after operation is started. Wait for about 40 seconds. ▶ Page 14
Air does not come out / Air comes out.	<ul style="list-style-type: none"> <input type="checkbox"/> ■ Is the airflow rate setting appropriate? <ul style="list-style-type: none"> • Is the airflow rate setting low, such as "Indoor unit quiet" or "1"? Increase the airflow rate setting. ■ Is the set temperature appropriate? ■ Is the adjustment of the airflow direction appropriate?
Air comes out.	<ul style="list-style-type: none"> <input type="checkbox"/> • Is there any furniture directly under or beside the indoor unit? • Is the air conditioner in ECONO operation? ▶ Page 25 • Are the air filters dirty? • Is there anything blocking the air inlet or air outlet of the indoor unit or outdoor unit? • Is the window or door open? • Is the exhaust fan turning? • Are the ventilating operation and air conditioning operation used at the same time? ▶ Page 24

Air has an odour

Case	Description / where to check
The air conditioner gives off an odour.	<ul style="list-style-type: none"> <input checked="" type="checkbox"/> • The air conditioner may take in an odour from outside. Stop humidifying operation and remove the cause of the odour. • When operation is switched to "SARARA" DRY operation, the humidity may increase temporarily, which may generate an odour. • The room odour absorbed in the unit is discharged with the airflow. We recommend you to have the indoor unit cleaned. Consult the service shop. • The air outlet may give out an odour because a small amount of ozone is generated. However, the amount is very small and does not harm your health. • This happens when the unit is in MOLD PROOF operation. ▶ Page 27

Commonly occurring sounds

Case	Description / where to check
Sound occurs during humidifying operation.	<ul style="list-style-type: none"> <input checked="" type="checkbox"/> ■ Operating sound is loud <ul style="list-style-type: none"> • In HUMID HEATING operation, the humidifying unit starts operating and therefore generates a slightly louder sound in the room. This sound is generated by the humidifying operation which becomes louder with increases in the airflow rate. • In ventilating operation, fresh air is taken in from outside. This may cause outside noise to sound loud. Operating sound becomes slightly louder as well. ▶ Page 24 ■ Operating sound changes <ul style="list-style-type: none"> • This happens when the humidifying fan starts or stops operating. • Outside sound may be loud.
Sound keeps coming out of the indoor unit even after humidifying operation is stopped.	<ul style="list-style-type: none"> <input checked="" type="checkbox"/> • To protect the air conditioner, the humidifying fan keeps turning for about another 3 minutes after operation is stopped.

Mist comes out

Case	Description / where to check
Mist comes out of the indoor unit.	<ul style="list-style-type: none"> <input checked="" type="checkbox"/> • This happens when the air in the room is cooled into mist by the cold airflow during COOLING or other operation. • This is because the air in the room is cooled by the heat exchanger and becomes mist during defrost operation.

Remote controller

Case	Description / where to check
The unit does not receive signals from the remote controller or has a low sensitivity.	<input checked="" type="checkbox"/> <ul style="list-style-type: none"> The batteries may be exhausted. Replace all the batteries with new dry batteries AA.LR6 (alkaline). For details, refer to "Preparation before operation". ▶ Page 9
LCD is faint, is not working, or displays erratically.	
Other electric devices start operating.	<input checked="" type="checkbox"/> <ul style="list-style-type: none"> If the remote controller activates other electric devices, move them away or consult the service shop.
2 air conditioners start operating at the same time.	<input checked="" type="checkbox"/> <ul style="list-style-type: none"> If you do not want to operate 2 air conditioners at the same time, change the address setting. ▶ Page 34

Display

Case	Description / where to check
The air conditioner is operating even with the OPERATION lamp off.	<input type="checkbox"/> <ul style="list-style-type: none"> Is the brightness of the indoor unit lamps set to "Off"? ▶ Page 10
The indoor unit lamps are dark.	<input type="checkbox"/> <ul style="list-style-type: none"> Is the brightness of the indoor unit lamps set to "Low"? ▶ Page 10
When operation is started, the OPERATION lamp blinks for a while and then lights up.	<input type="checkbox"/> <ul style="list-style-type: none"> Check the error code and consult the service shop. ▶ Page 40
The TIMER lamp blinks.	<input type="checkbox"/> <ul style="list-style-type: none"> Clean the streamer unit. ▶ Page 36
The MOLD PROOF / CLEANING FILTER lamp blinks.	<input type="checkbox"/> <ul style="list-style-type: none"> Clean the dust box. ▶ Page 37
The MOLD PROOF / CLEANING FILTER lamp blinks even after the dust box is cleaned.	<input type="checkbox"/> <ul style="list-style-type: none"> Reset the dust box cleaning indicator. If the MOLD PROOF / CLEANING FILTER lamp still blinks, consult the service shop.

FLASH STREAMER AIR PURIFYING operation

Case	Description / where to check
There is a sign of burning on the metal section of the streamer unit.	<input checked="" type="checkbox"/> <ul style="list-style-type: none"> This is a sign of streamer discharge and normal.
FLASH STREAMER AIR PURIFYING operation cannot be performed.	<input type="checkbox"/> <ul style="list-style-type: none"> Is the front panel open? Close the front panel. ▶ Page 35 Is the streamer unit securely installed?
The sound of streamer discharge stopped.	<input type="checkbox"/> <ul style="list-style-type: none"> Is the needle tip of the streamer unit dirty? Clean the needle. ▶ Page 36 Streamer discharge stops when the indoor temperature becomes close to the set temperature and the airflow rate decreases.

INTELLIGENT EYE sensor

Case	Description / where to check
The sensor does not respond.	<input type="checkbox"/> <ul style="list-style-type: none"> The sensor is warming up for about 2 minutes after operation is started. Wait for a while. The sensor may not recognise small movements such as those made by sleeping persons or small children. The sensor may not work well if the indoor temperature is high. Even if the indoor temperature is low, the sensor may not recognise well persons whose clothing is cold just after coming back home in winter. The sensor does not work well especially when the person wears thick clothing. The sensor may not work well when a floor heating appliance or electric carpet is used. Make sure that the front panel is properly attached. If the front panel is not completely attached, the scope of the INTELLIGENT EYE sensor may become narrower. If the front panel is dirty, the sensor may not work. Clean the front panel. ▶ Page 35

Troubleshooting (for service personnel)

CLEANING FILTER operation

Case	Description / where to check
CLEANING FILTER operation does not function.	<ul style="list-style-type: none"> ✓ To protect the air filters, CLEANING FILTER operation is not performed when the indoor temperature is 10°C or lower. ▶ Page 29 • This happens when the MOLD PROOF / CLEANING FILTER lamp is blinking. Clean the dust box and reset the dust box cleaning indicator. ▶ Page 37
CLEANING FILTER operation is long.	<ul style="list-style-type: none"> ✓ This is to protect the air conditioner. After humidifying or ventilating operation is stopped, CLEANING FILTER operation is not performed until the humidifying fan stops. Wait for about 15 minutes.
CLEANING FILTER operation does not stop. [MOLD PROOF / CLEANING FILTER lamp is off]	<ul style="list-style-type: none"> ✓ ■ After the operation has been stopped manually <ul style="list-style-type: none"> • The air filter is moving back to the normal position. Wait for up to about 3 minutes.
The air filter gets stuck during CLEANING FILTER operation.	<ul style="list-style-type: none"> ? • Check to see whether the filter section of the air filter is not deformed. • Check to see whether the air filter, air-purifying and deodorising filter, and dust box are properly attached. ▶ Page 37 - 39 <p>If the filter section of the air filter is deformed, consult the service shop.</p>
A large noise occurs in CLEANING FILTER operation.	
The air filter is still dirty even after CLEANING FILTER operation is performed.	<ul style="list-style-type: none"> ? • Is there too much dust in the dust box? ▶ Page 37 • Grease and tar from tobacco may not be removed completely. Clean the air filter. ▶ Page 38

Others

Case	Description / where to check
Cold air comes out of the air conditioner when "SARARA" DRY operation is started.	<ul style="list-style-type: none"> ✓ • This is to quickly reduce the humidity.
Warm air comes out of the air conditioner during "URURU" HUMIDIFY operation.	<ul style="list-style-type: none"> ✓ • The air conditioner may perform weak HEATING operation when the indoor temperature becomes low.
The flaps do not close when operation is stopped.	<ul style="list-style-type: none"> ? • Did anyone touch the flaps while the air conditioner is in operation? Restart operation and stop it again to properly close the flaps.
The air conditioner suddenly starts showing strange behaviour during operation.	<ul style="list-style-type: none"> ? • The air conditioner may malfunction due to lightning or radio. If the air conditioner malfunctions, turn off the power with the circuit breaker and restart the operation with the remote controller.

Notes on operating conditions

- The air conditioner always consumes a small amount of electricity even while it is not operating.
- If the operation is continued under any conditions other than the table below,
 - A safety device may activate to stop the operation.
 - Dew may form on the indoor unit and drip from it when COOLING or "SARARA" DRY operation is selected.

	COOLING	"SARARA" DRY	HEATING	"URURU" HUMIDIFY
Outdoor temperature	-10-43°C	18-42°C	-20-24°C	-10-24°C
Indoor temperature	18-32°C	18-30°C	10-30°C	12-30°C
Indoor humidity	80% max.	80% max.	70% max.	70% max.

Call the service shop immediately



WARNING

- **When an abnormality (such as a burning smell) occurs, stop operation and turn the circuit breaker off.**
 - Continued operation in an abnormal condition may result in troubles, electric shocks or fire.
 - Consult the service shop where you bought the air conditioner.
- **Do not attempt to repair or modify the air conditioner by yourself.**
 - Incorrect work may result in electric shocks or fire.
 - Consult the service shop where you bought the air conditioner.

If one of the following symptoms takes place, call the service shop immediately.

- The power cord is abnormally hot or damaged.
- An abnormal sound is heard during operation.
- The circuit breaker, a fuse, or the earth leakage circuit breaker cuts off the operation frequently.
- A switch or a button often fails to work properly.
- There is a burning smell.
- Water leaks from the indoor unit.

Turn off the circuit breaker and call the service shop.



■ After a power failure

- The air conditioner automatically resumes operation in about 3 minutes. You should just wait for a while.
- When AUTO RESTART is "Off", start the operation using the remote controller.

■ Lightning

- If lightning may strike the neighbouring area, stop operation and turn the circuit breaker off for system protection.

■ When not in use for extended periods

- 1) Perform MOLD PROOF operation on a sunny day to dry the inside well. (How to perform MOLD PROOF operation. ▶ [Page 27](#))
- 2) After operation is stopped, turn off the circuit breaker for the air conditioner.
- 3) Remove the batteries from the remote controller.
 - To resume using the air conditioner, turn on the circuit breaker. The air conditioner performs the operating check of each part.

Disposal requirements



Your product and the batteries supplied with the controller are marked with this symbol. This symbol means that electrical and electronic products and batteries shall not be mixed with unsorted household waste.

For batteries, a chemical symbol can be printed beneath the symbol. This chemical symbol means that the battery contains a heavy metal above a certain concentration. Possible chemical symbols are:

■ Pb: lead (>0.004%)

Do not try to dismantle the system yourself: the dismantling of the product, treatment of the refrigerant, of oil and of other parts must be done by a qualified installer in accordance with relevant local and national legislation.

Units and waste batteries must be treated at a specialized treatment facility for re-use, recycling and recovery.

By ensuring correct disposal, you will help to prevent potential negative consequences for the environment and human health.

Please contact the installer or local authority for more information.

Important information regarding the refrigerant used

- This product contains fluorinated greenhouse gases covered by the Kyoto Protocol.
Refrigerant type: **R32**
GWP⁽¹⁾ value: **550 ***
(1) GWP = global warming potential
- Periodical inspections for refrigerant leaks may be required depending on European or local legislation. Please contact your local dealer for more information.
 - * This value is based on F gas regulation (842/2006).



DAIKIN INDUSTRIES, LTD.

Head office:
Umeda Center Bldg., 2-4-12, Nakazaki-Nishi,
Kita-ku, Osaka, 530-8323 Japan

Tokyo office:
JR Shinagawa East Bldg., 2-18-1, Konan,
Minato-ku, Tokyo, 108-0075 Japan
<https://www.daikin.com>

DAIKIN ISITMA VE SOĞUTMA SİSTEMLERİ SAN. TİC. A.Ş.

Gülsuyu Mahallesi, Fevzi Çakmak Caddesi, Burçak Sokak No:20
34848 Maltepe / İSTANBUL / TÜRKİYE
Tel: 0216 453 27 00
Faks: 0216 671 06 00
Çağrı Merkezi: 444 999 0
Web: www.daikin.com.tr

DAIKIN EUROPE N.V.

Zandvoordestraat 300, B-8400 Oostende, Belgium

EAC



The two-dimensional bar code is
a manufacturing code.

3P338603-1G M12B405F (2009) HT