



Quick Guide

Ver. 1
Release date: III 2023



Producer:
Engo Controls S.C.
43-200 Pszczyna
3E Górnośląska St.
Poland

Distributor:
QL CONTROLS Sp z o. o. Sp. k.
43-262 Koblence
4 Rolna St.
Poland

www.engocontrols.com

Technical specifications

Power supply	230 V AC 50 Hz
Total Load Max	10 A
Pump Load Max	3A
Boiler Load Max	6A
Actuator Load Max	2A
Thermostat Load Max	1A
Outputs	Boiler control (NO/COM/NC) Pump control (AC 230V) Terminals for actuators (AC 230V)
Dimensions [mm]	330 x 110 x 36

Control box description

- Inputs for wired thermostats
- Connection zones for ZigBee wireless thermostats
- "Select" Button
- "Pair" Button
- LED diodes indicators for the operation status of the pump, boiler and control box power supply connection
- External antenna input
- Heating device control output, e.g. gas boiler (voltage free)
- Pump control output (AC 230V)
- Ground
- Power supply (AC230V)
- Cartridge fuse 5 x 20 mm 10A
- Actuators output connections (AC 230V)
- LEDs 1 to 8 informing about the operation of zones

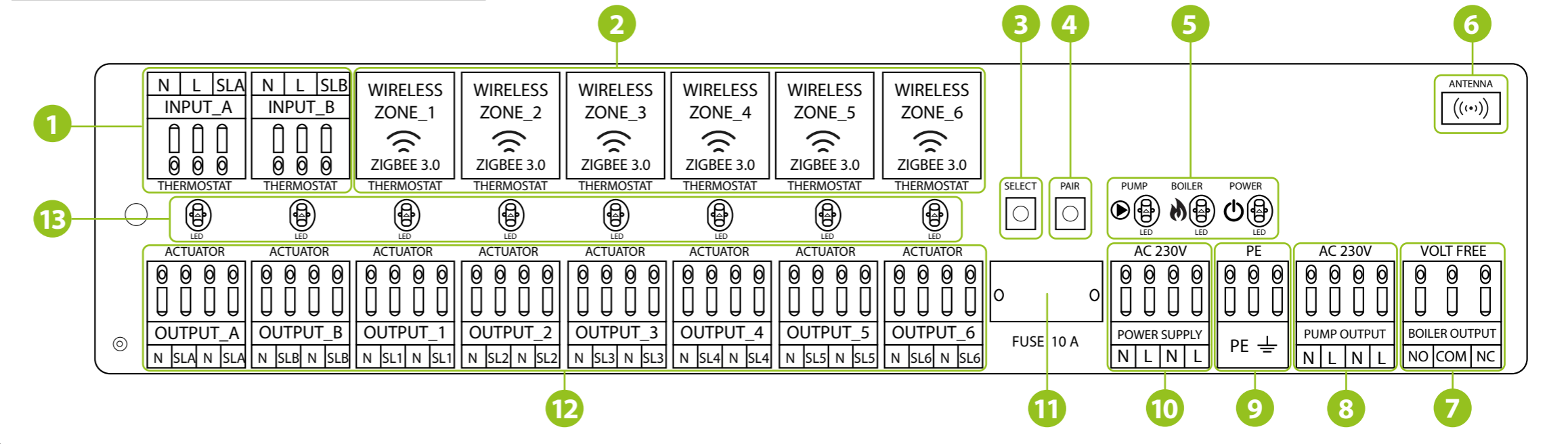

Introduction:

ECB62ZB control box is the main element of the underfloor heating control system. It is equipped with 230V voltage connectors for the thermostats, pump, and thermoelectric actuators. It allows for the control of 8 heating zones in a combination of connections - 2 wired and 6 wireless thermostats. It works with NC-type thermoelectric actuators, e.g. E30NC230 and E28NC230. The ECB62ZB has a built-in control module for heating devices, e.g. gas boiler (voltage free output). Wired control is done by directly connecting the thermostat to the control box by wires. The applied thermostats can be battery-powered or powered by 230V AC voltage. Wireless communication is over ZigBee 3.0 technology. The "ENGO binding" function provides wireless and direct control to dedicated EONEBAT, EONE230 thermostats using the EGATEZB internet gateway. Additionally, EGATEZB gateway makes possible to control ECB62ZB control box over Internet by ENGO Smart/TUYA Smart mobile applications.

Product compliance

This product complies with the essential requirements and other relevant provisions of the following EU Directives: EMC 2014/30/EU, Low Voltage Directive LVD 2014/35/EU, RoHS directive 2011/65/EU

Safety information

Use in accordance with national and EU regulations. Device is intended for indoor use only in dry conditions. Product for indoor use only. Installation must be carried out by a qualified person in accordance to national and EU regulations. Before attempting to setup and install, make sure that ECB62ZB is not connected to any power source. Installation must be carried out by a qualified person. Incorrect installation may cause damage to the wiring centre. The ECB62ZB should not be installed in areas where it may be exposed to water or damp conditions.

PLEASE NOTE:

For the entire installation, there may be additional protection requirements, which the installer is responsible for maintaining.

Connection of thermostats and thermoelectric actuators (AC 230V)

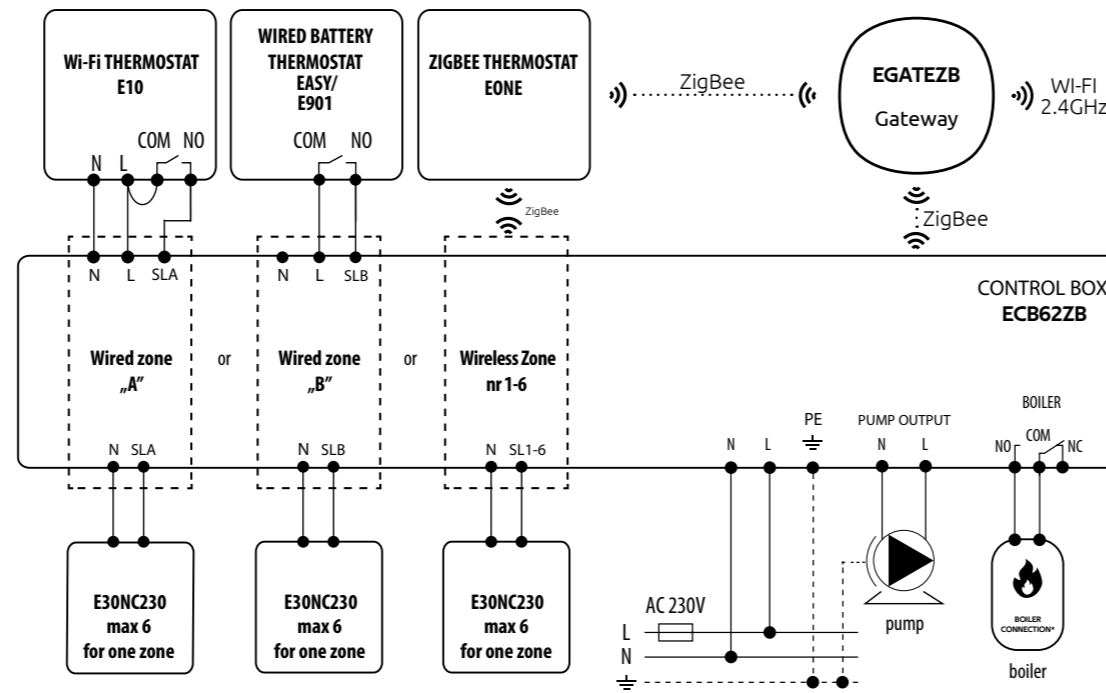

When the actuator has no power, it is closed. After applying 230V voltage, the actuator will open.

Example based on E30NC230 actuators.

The control box is adapted to work with NC type actuators (normal closed). The wires of the thermoelectric actuators should be plugged in removable connectors in the appropriate zones. Current load of each zone is adapted to support up to 6 thermoelectric actuators with a power of 2 W. With more actuators in one zone, use additional relay to relieve the output of this zone.

Please note:

Depends on the thermostat heating state - 230 V AC may appear on the actuators output

INSTALLATION

- Remove the top cover of the control box**
- Remove the appropriate piece of insulation from the wires**
 - Wires for boiler and battery thermostats (min. 2 x 0,75 mm² 230 V max. 2 x 1,5 mm² 230 V)
 - Power supply for the wiring centre, pump and 230V voltage thermostats (min. 3 x 1,0 mm² 230 V max. 3 x 1,5 mm² 230 V)
- Connect the wires in accordance with the connection description. Refer to the sticker under the top cover.**
- After making sure all wires are properly connected, mount the top cover and plug the wiring centre to the 230 V power supply - the red "Power" diode will light up.**

Power supply

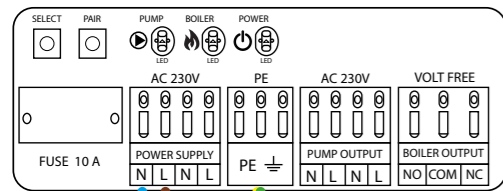

Power supply for wiring centre is 230 V ~ 50Hz.

- Installation features:
- three-wire,
 - made in accordance with applicable regulations.

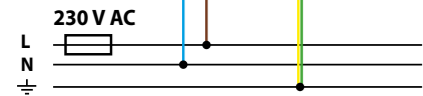

The red LED indicates that the wiring centre is connected to the power supply.

Fuse

Please note:

Replacement of the fuse to be carried out only when the control box is disconnected from power supply (230 V ~). Main fuse is located under the housing cover next to power supply terminals and secures the control box and the devices connected to it. Use slow-blow tubular fuses with nominal current 10A burnout. To replace fuse remove the fuse holder with a flat screwdriver and pull out the fuse.

Pump control output (AC 230V)

The PUMP OUTPUT is used to power the circulation pump in the heating system. It is a 230V AC voltage output with a maximum load capacity of 3A. The pump is connected directly to the contacts. The output is turned on (the pump starts) always after 3 minutes from the moment of receiving a heating signal from any thermostat connected to the wiring centre. The output is turned off (the pump stops) as soon as the last thermostat stops reporting heat demand.

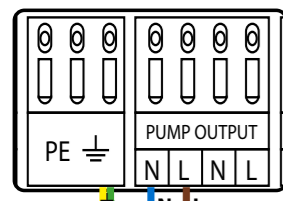

When the Pump/Valve control output is activated, the pump status LED shows a constant green light.

PLEASE NOTE: Before starting the installation, disconnect the 230V power supply!

max
3 A

Boiler control output (voltage free)

The boiler control output is supported by a relay with voltage-free contacts (NO / COM / NC output). The boiler must be connected to the COM-NO or COM-NC contacts. It is a typical two-state relay. If the thermostats connected to the wiring centre send a signal for heating, the BOILER output contacts activate the relay with a 3-minute delay, allowing the boiler to be turned on. The boiler is turned off immediately, when none of the zones sends a signal for heating.

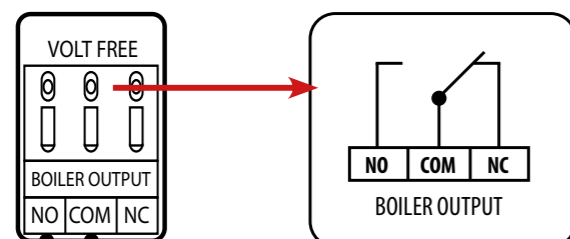

Boiler ON/OFF contacts (according to the boiler's manual)

When the BOILER control output is activated, the boiler status LED shows a constant green light.

Installation ECB62ZB in the app

Make sure your router is within range of your smartphone. Make sure you are connected to the Internet. This will reduce the pairing time of the device.

STEP 1 - DOWNLOAD ENGO SMART APP



Download the ENGO Smart app from Google Play or Apple App Store and install it on your smartphone



STEP 2 - REGISTER THE NEW ACCOUNT

To register a new account, please follow the steps below:

1. Click "Register" to create new account.
2. Enter your e-mail address to which the verification code will be sent.
3. Enter the verification code received in the email. Remember that you only have 60 seconds to enter the code!!
4. Then set the login password.

STEP 3 - INSTALLATION ECB62ZB IN THE APP



Make sure ZigBee gateway has been added to the Engo Smart app



Make sure that the control box is connected to the power supply. Press and hold the PAIR button for 10 seconds, red LED diode will start flashing red. The control box will go into pairing mode.

1. Select "Add Device".
2. When the ZigBee gateway finds control box click the "Add" button.
3. Name the device and click "Done".
4. The control box has been installed and displays the main interface. Power diode lights up blue.

BINDING THERMOSTAT WITH THE ECB62ZB WIRELESS CONTROL BOX

Make sure that the ECB62ZB control box and thermostat are in the same ZigBee network (they are added to the same gateway EGATEZB) and the POWER LED lights up blue.

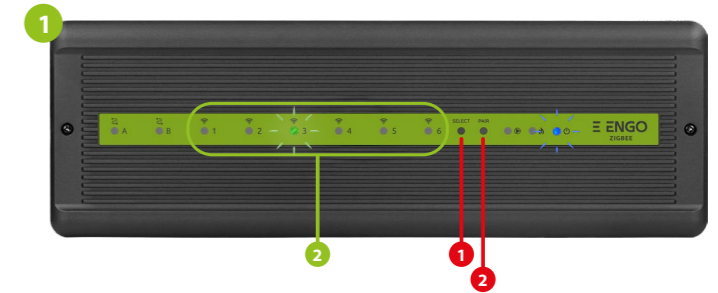

In order to correctly link thermostat with the control box, first select the zone in the control box with the SELECT button (1) (zone which you want to link with thermostat). The LED (2) will flash 3 times for the selected zone. Confirm your selection by clicking PAIR button (2). The LED (2) will flash green with the previously selected zone - binding process has started, it is active for 10 minutes and during this time you can link thermostat with the selected zone.

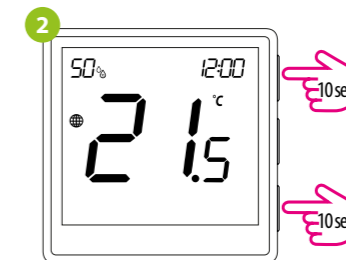

On the EONE thermostat, hold ▲ and ▼ buttons until the "bind" message appears.

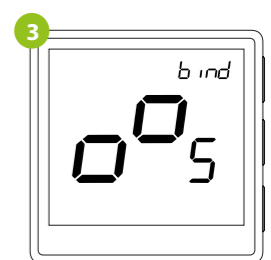

Release the keys, binding function process of linking thermostat with control box is active.

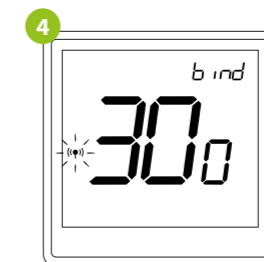

The "binding" process takes up to 300 seconds.

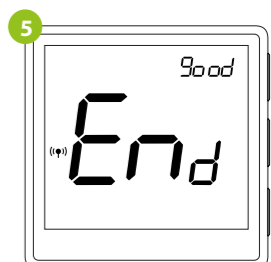

After successful binding operation "End" message will be displayed.

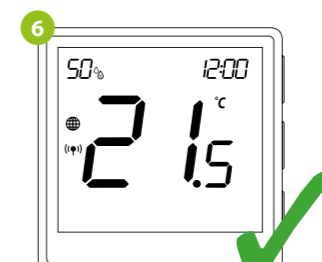

Both devices have been successfully linked. Thermostat displays the main screen, icon "(())" appeared on the screen indicating connection with the receiver (ECB62ZB in this case).

ATTENTION:

If the binding process fails, it must be repeated taking into account the distances between devices, obstacles and local radio signal interferences.

Remember: Radio range can be increased by Engo ZigBee repeaters.

Factory reset

To restore the factory settings, press and hold the PAIR button for 10 seconds, red LED diode will start flashing red. The control box will be cleared from the ZigBee network and gateway memory and enters the pairing mode. You can add it back to the ZigBee network (see STEP 3 - Installation ECB62ZB in the app).