

TECH
CONTROLLERS



INSTALLATION CONTROLLERS



TECH
CONTROLLERS

ABOUT US

Our company manufactures microprocessor devices for consumer electronics. We are the largest Polish manufacturer of controllers for CH boilers fired with solid fuels. We have been trusted by the leading CH boiler companies in Poland and abroad. Our devices are characterized by the highest quality and reliability, confirmed by many years of experience.

We specialize in designing and production of controllers for CH boilers fired with coal, fine coal, pellet, wood and biomass (oats, corn, dried seeds). Apart from that, we also manufacture regulators for refrigeration industry, solar systems, sewage treatment plants, mushroom farms, three- and four-way valves as well as room regulators and scoreboards for sports playfields.

We have already sold hundreds of thousands of various controllers and we are successfully expanding our offer, with the customer satisfaction being our top priority. The quality management system ISO 9001 and a number of certificates confirm the highest quality of our products.

The history of our company are, first of all, the people who create it, their knowledge, experience, involvement and persistence. Our plans for the future include maintaining good relations with our customers, acquiring new customers and developing new, high-quality products.

TABLE OF CONTENTS

PUMP CONTROLLERS

EU-19, 20, 21 Pump controllers	4
EU-21 CWU DHW pump controller	6
EU-21 BUFOR Buffer pump controller	6
EU-11 DHW circulation regulator	8
EU-27i Two pumps controller	10
EU-427i Three pumps controller	10

MIXING VALVE CONTROLLERS

EU-i-1 Mixing valve controller	12
EU-i-1 DHW Mixing valve + DHW pump controller	12
EU-i-1m Mixing valve module	14
EU-i-2 PLUS Installation controllers	16
EU-i-3 PLUS Installation controller	18

ROOM REGULATORS WITH RS COMMUNICATION

EU-RI-1 Room regulator with RS communication	20
EU-280, 281 Room regulator with RS communication	22

OPENTHERM ROOM REGULATORS

EU-2801 WiFi Room regulator with OpenTherm communication + WiFi	24
EU-WiFi OT Room regulator with OpenTherm communication + WiFi	26

ADDITIONAL MODULES

EU-505, WiFi RS Internet modules	28
EU-517 2 heating circuit module	30

RENEWABLE ENERGY CONTROLLERS

EU-401n Solar collector controllers	32
EU-402n PWM Solar collector controllers	34

MIXING VALVE ACTUATORS

STZ-120 T Mixing valve actuator	38
STZ-180 RS Mixing valve actuator	40

INVERTER

STI-400 Inverter	42
-------------------------------	----

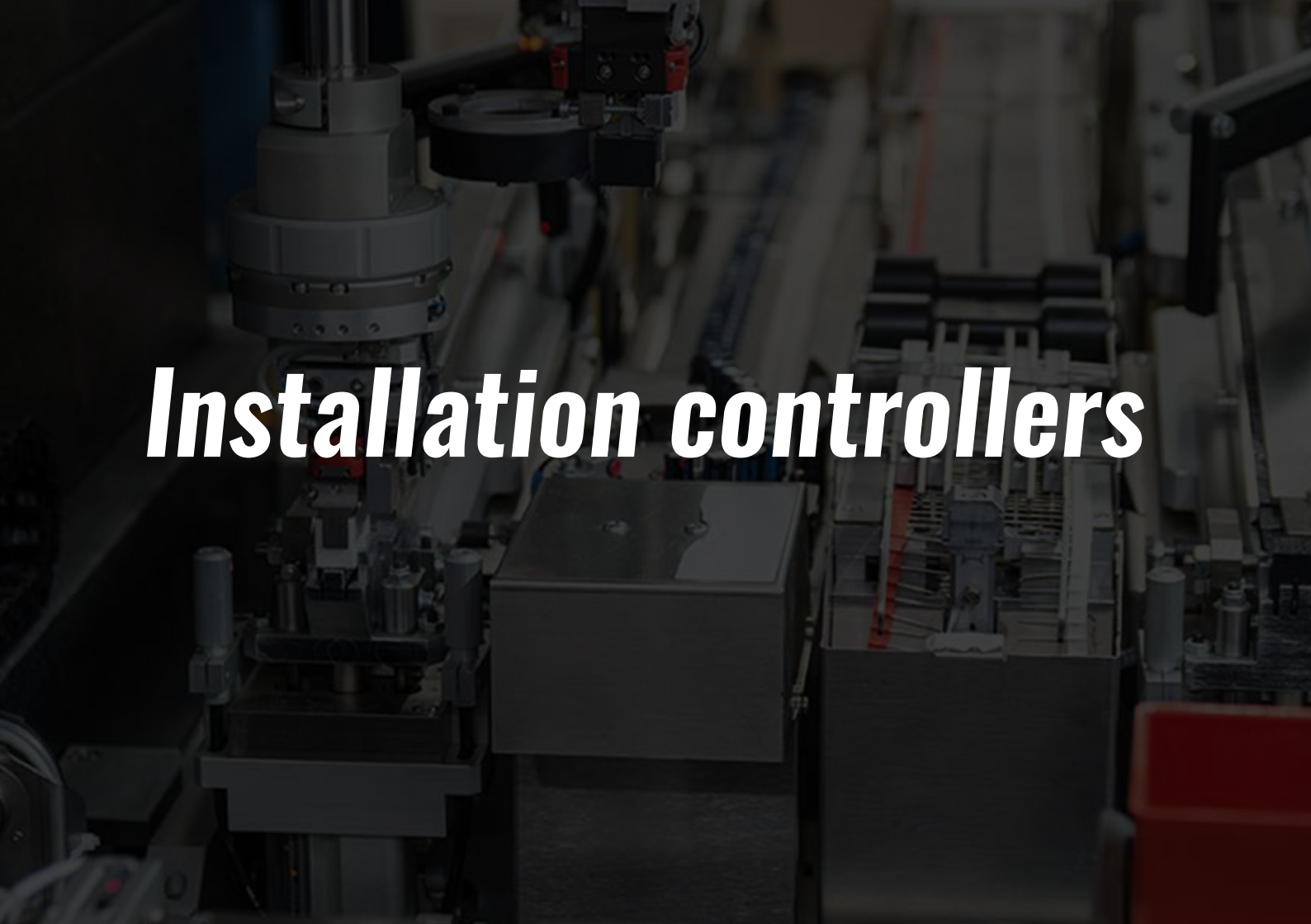
The background of the image shows a complex industrial machine, possibly a robotic assembly line or a precision manufacturing tool. The machine is composed of various metal parts, including cylindrical components, gears, and structural frames. The lighting is somewhat dim, and the overall color palette is muted, with greys, blacks, and some hints of red and blue. A dark, semi-transparent overlay covers the entire image, which makes the white text stand out prominently.

Installation controllers

EU-19, 20, 21

PUMP CONTROLLERS



Power supply	230V 50Hz
Pump output load	1 A
Temperature setting range	25°C - 85°C
Temp. measurement accuracy	+/- 1°C
Dimensions [mm]	137 x 96 x 40

Functions

- CH pump control

Equipment

- CH temperature sensor

EU-19

- anti-stop function
- potentiometer for setting the desired temperature

EU-20

- potentiometer for setting the desired temperature

EU-21

- possibility of working as a thermostat
- anti-stop function
- anti-freeze function
- possibility to set the pump activation temperature and the minimum deactivation temperature: -9°C
- LED display

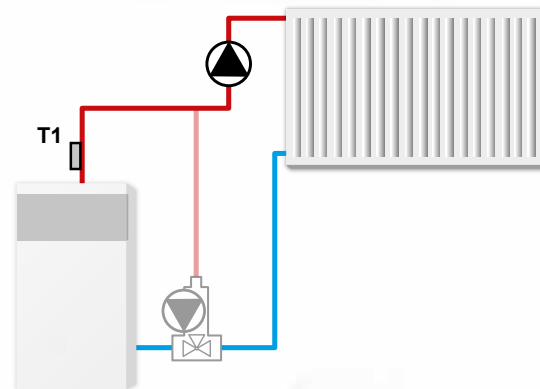

EU-21 DHW, EU-21 BUFFER

DHW & BUFFER PUMP CONTROLLERS



Power supply	230V 50Hz
Pump output load	1 A
Temperature setting range	25°C - 85°C
Voltage-free contact load	1A / 230 V / AC
Temp. measurement accuracy	+/- 1°C
Dimensions [mm]	110 x 163 x 57

Functions

- DHW pump control
- anti-stop function
- anti-freeze function
- control of the voltage-free output
- possibility of defining pump activation delta
- protection against DHW tank cooling

Equipment

- LED display
- two temperature sensors

Principle of operation

EU-21 DHW regulator is a multi-purpose controller equipped with two temperature sensors, intended for controlling DHW tank pump. The controller activates the pump when the **temperature difference between the two sensors exceeds set value ($T1 - T2 \geq \Delta$)**, provided that **$T2 \geq$ Minimum threshold of pump activation**.

The pump is deactivated when **$T2 \leq T1 + 2^\circ\text{C}$** or when **$T1 <$ Minimum threshold of pump activation $- 2^\circ\text{C}$ (constant hysteresis value)** or when **$T2$ reaches the set value**. Key: T1 – CH boiler temperature T2 – DHW tank temperature (buffer).

It prevents unnecessary pump operation as well as unintended cooling down of the DHW tank when the water supply temperature drops. This, in turn, helps to save electricity and prolongs the life of the pump. Consequently, the device is more reliable and economical.

EU-21 DHW regulator is equipped with a system preventing pump stalling during long standstill. The pump is switched on for 1 minute every 10 days. Additionally, the controller is equipped with anti-freeze function. When the temperature of CH boiler sensor or DHW tank sensor drops below 6°C , the pump is activated permanently. It is switched off when the circuit temperature reaches 7°C .

EU-21 CWU

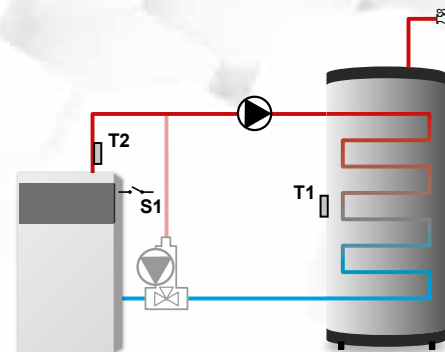

EU-21 BUFOR

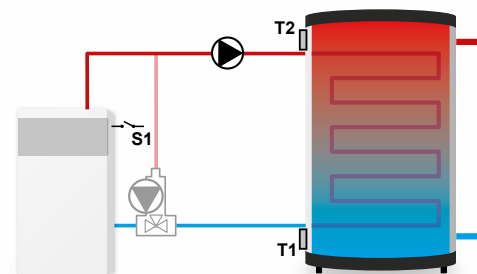

EU-11

DHW CIRCULATION REGULATOR

Power supply	230V / 50Hz
Maximum power consumption	< 3W
Load	1A
Fuse	1.6 A
Operating pressure	1-8 bar
Minimum flow to activate	1 liter/min.
Operating temperature	5°C - 60°C



Functions

- controlling circulating pump operation
- monitoring the pre-set temperature in a heating circuit
- smart control of the circulation system
- protection against overheating (DHW pump activation)
- anti-stop function
- adjustable pump operation time

Equipment

- 2 temperature sensors (one for circulation circuit and one for tank)
- flow sensor
- LCD display

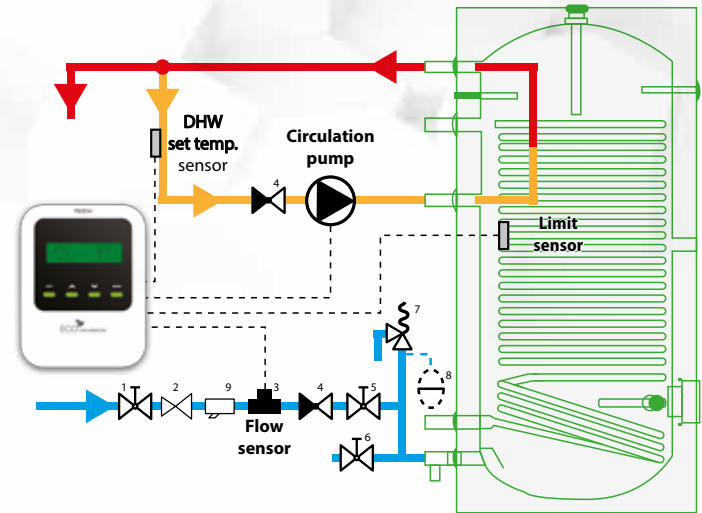

Principle of operation

DHW circulation regulator is intended for controlling DHW circulation to suit individual user's needs. In an economical and convenient way, it reduces the time needed for hot water to reach the fixtures. It controls the circulating pump which, when the user draws water, accelerates the flow of hot water to the fixture, exchanging the water there for hot water at the desired temperature in the circulation branch and at the tap. The system monitors the temperature set by the user in the circulation branch and it activates the pump only when the pre-set temperature drops. Thus it does not generate any heat loss in the DHW system. It saves energy, water and equipment in the system (e.g. circulation pump). The circulation system operation is activated again only when hot water is needed and at the same time the pre-set temperature in the circulation branch drops. The device regulator offers all the functions necessary to adjust to various DHW circulation systems. It may control hot water circulation or enable the circulating pump in case of heat source overheating (e.g. in solar heating systems). The device offers pump anti-stop function (protecting against rotor lock) and adjustable working time of circulation pump (defined by the user).

EU-27i, EU-427i

CONTROLLER FOR TWO/THREE PUMPS



Power	230V 50Hz
Pumps output load	1A
Range of temperature setting	30°C - 70°C
Accuracy of temp. measurement.	+/- 1°C
Dimensions [mm]	125 x 200 x 55

Functions (EU-27i)

- CH pump control
- control of additional DHW or floor pump
- anti-stop function
- anti-freeze function

Principle of operation

EU-27i regulator is intended to control the operation of CH circulation pump and of the additional pump (DHW or floor pump). The controller's task is to switch the CH pump on if the temperature exceeds the threshold value of activation and to switch the pump off when the boiler cools down (e.g. as a result of burnout). For the second pump, apart from activation temperature, the user adjusts the set temperature up to which the pump will operate.

Equipment (EU-27i)

- LCD display
- CH temperature sensor T1
- additional pump temperature sensor T2
- control knob
- casing designed for mounting on the wall

EU-27i

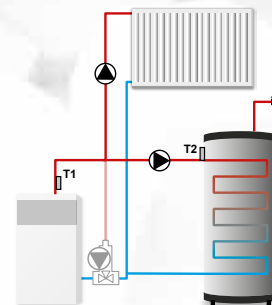

Functions (EU-427i)

- time-based or temperature-based control of the three pumps
- anti-stop function
- anti-freeze function
- possibility of setting any pump priorities
- possibility of connecting a room regulator with traditional communication (a two-state regulator – ON/OFF)

Principle of operation

EU-427i regulator is intended to control the operation of three pumps. The controller's task is to switch the pumps on (temporarily if the temperature exceeds the threshold value of activation) and off when the boiler cools down (e.g. as a result of burnout). If a selected pump is not a CH pump, turning off can be realized by signal from room regulator. Apart from activation temperature, the user adjusts the set temperature up to which the pump will operate. There is a possibility to set any priorities of the pumps' operation.

Equipment (EU-427i)

- LCD display
- three temperature sensors
- control knob
- casing designed for mounting on the wall

EU-427i

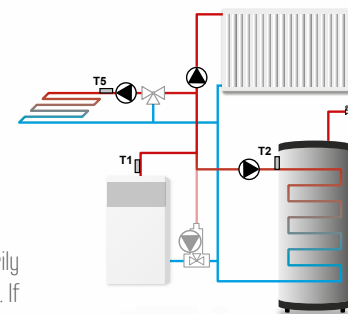

EU-i-1, EU-i-1 DHW

MIXING VALVE CONTROLLER



eModul

CONTROL VIA MOBILE APP
ADDITIONAL INTERNET MODULE NECESSARY



Power supply	230V 50Hz
Pump output load	0,5 A
Valve output load	0,5 A
Accuracy of temperature measurement	+/- 1°C
Dimensions [mm]	110 x 163 x 57



Functions

- smooth control of a three- or four-way valve
- control of valve pump operation
- **control of additional DHW pump (EU-i-1 DHW)**
- **control of voltage-free output (EU-i-1 DHW)**
- possibility of controlling two other valves using additional modules EU-431n or i-1
- compatible with modules EU-505 and WIFI RS - eModul application
- return temperature protection
- weather-based and weekly control
- compatible with room regulators using RS or two-state communication

Equipment

- LCD display
- CH boiler temperature sensor
- return temperature sensor and valve temperature sensor
- **DHW temperature sensor (EU-i-1 DHW)**
- external sensor
- wall-mountable housing

Principle of operation

The i-1 thermoregulator is designed to control a three-way or four-way mixing valve with the possibility of connecting additional valve pump. Optionally, this controller may cooperate with two modules, enabling the user to control up to three mixing valves. The i-1 DHW controller is designed to operate a three-way or four-way mixing valve with the option of connecting a valve pump and additional DHW pump as well as a voltage-free contact for a heating device.

EU-i-1

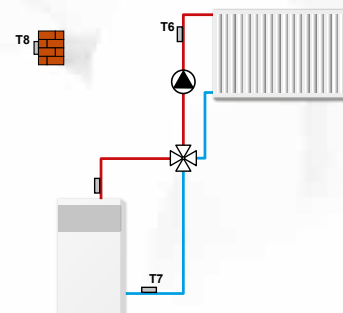

EU-i-1 DHW

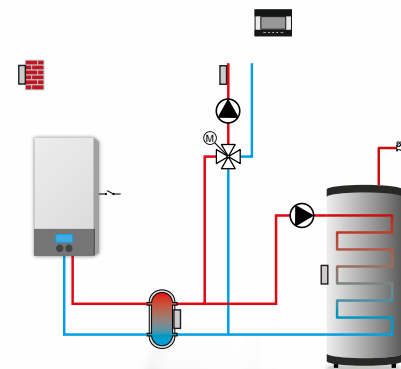

EU-i-1m

MIXING VALVE MODULE

Power supply	230V 50Hz
Pump output load	0,5 A
Valve output load	0,5 A
Accuracy of temperature measurement	+/- 1°C
Dimensions [mm]	110 x 163 x 57



Functions

- smooth control of a three- or four-way valve
- control of valve pump operation
- cooperating with main controllers using RS communication

Equipment

- CH boiler temperature sensor
- valve temperature sensor
- return temperature sensor
- external sensor
- wall-mountable housing

Principle of operation

EU-i-1m expanding module is intended for controlling a three- or four-way valve by connecting it to the main controller.

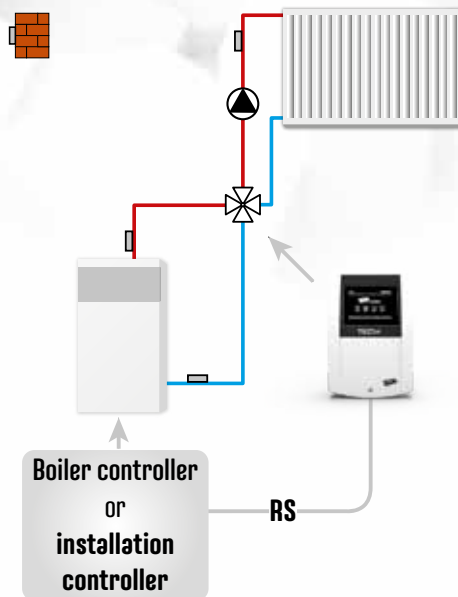

EU-i-2 PLUS

INSTALLATION CONTROLLER



INSTALLATION CONTROLLERS

Modern low-energy houses require several alternative sources of heat. However, if you want the house to generate real savings, you need one system that will manage them. TECH heating controllers allow for efficient control of the heating system including multiple heat sources (e.g. solar collectors and CH boiler), thereby limiting energy consumption. Incorporating controllers into the heating system makes it easy for the user to operate all devices, helps to save time and money as well as ensures the best thermal comfort.

Functions

- smooth control of **two mixing valves**
- control of DHW pump
- **two configurable 0-10V outputs**
- **control of the cascade of up to 4 heating devices**
- **ability of adjusting parameters of heating device via OpenTherm communication**
- return temperature protection
- weekly control and weather-based control
- two configurable voltage-free outputs
- two configurable voltage outputs
- cooperation with **two two-state room regulators**
- compatible with RS room regulators
- compatible with EU-505 module and WIFI RS module
- control via **eModul app**
- possibility of controlling two additional valves using **additional modules EU-i-1 or EU-i-1-m**

Equipment

- LCD display
- CH boiler temperature sensor
- DHW temperature sensor
- valve temperature sensors
- return temperature sensor
- external sensor
- wall-mountable housing

eModul

CONTROL VIA MOBILE APP
ADDITIONAL INTERNET MODULE NECESSARY

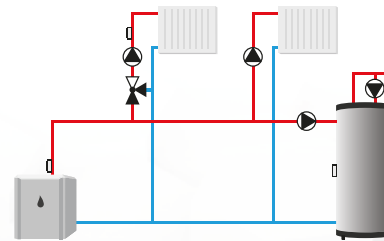
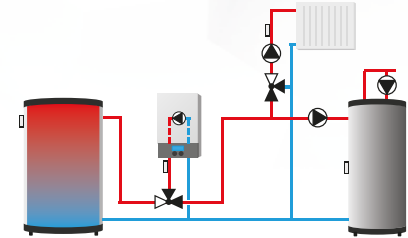
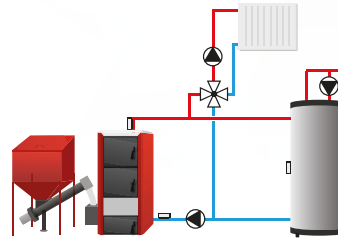

EU-i-3 PLUS

INSTALLATION CONTROLLER



PRINCIPLE OF OPERATION

Installation controllers allow simultaneously connection of several heating sources (up to three mixing valves and two additional mixing valves) and several room regulators (thanks to them various temperature levels can be programmed in different rooms)

In addition, installation controllers made by TECH allow to connect additional modules such as Ethernet module or GSM module. Controllers are equipped with big touchscreen and USB port for updates

Functions

- smooth control of **three mixing valves**
- control of DHW pump
- **solar system control**
- **control of solar pump via PWM signal**
- **two configurable 0-10V outputs**
- **control of the cascade of up to 4 heating devices**
- **ability of adjusting parameters of heating device via OpenTherm communication**
- return temperature protection
- weekly control and weather-based control
- two configurable voltage-free outputs
- two configurable voltage outputs
- cooperation with **three two-state room regulators**
- compatible with RS room regulators
- compatible with EU-505 module and WIFI RS module
- control via **eModul app**
- possibility of controlling two additional valves using **additional modules EU-i-1 or EU-i-1-m**

eModul

CONTROL VIA MOBILE APP
ADDITIONAL INTERNET MODULE NECESSARY

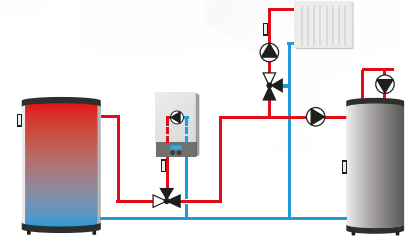
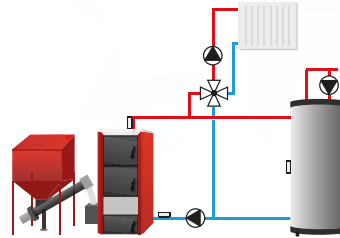

Equipment

- LCD display
- CH boiler temperature sensor
- valve temperature sensors
- return temperature sensor
- solar collector temperature sensor
- external sensor
- wall-mountable housing

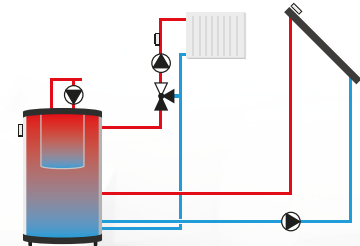
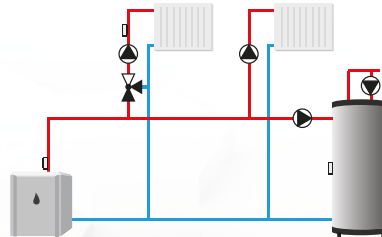

EU-RI-1

DEDICATED FOR I-2, I-3, I-3 PLUS
ROOM REGULATOR
WITH RS COMMUNICATION

Power	5 V
Wired communication RS	cord 4 x 0,14 mm ²
Temp. measurement accuracy	+/- 0,5 °C
Dimensions [mm]	95 x 95 x 25



Functions

- controlling room temperature
- day/night program,
- manual mode
- additional control based on floor temperature
- hysteresis 0,2 - 4°C,
- wired communication,

Equipment

- built in temperature sensor,
- temporary display backlight,
- RS communication,

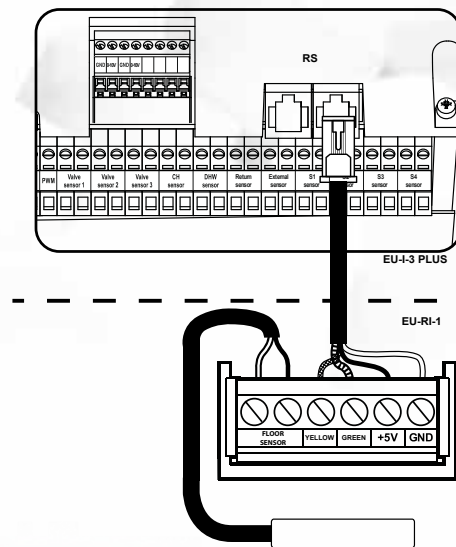

EU-280, EU-281

ROOM REGULATOR WITH RS COMMUNICATION

available in black or white casing
(EU-281, EU-281C)



Power	Power supply - operating module
Wired communication	EU-280 i EU-281 cord 4x0,14 mm ²
Wireless communication Frequency	EU-281 C 868 MHz
Temp. measurement accuracy	+/- 0,5 °C
Dimensions [mm] EU-280	145 x 102 x 24
Dimensions [mm] EU-281 i EU-281 C	127 x 90 x 20



EU-280

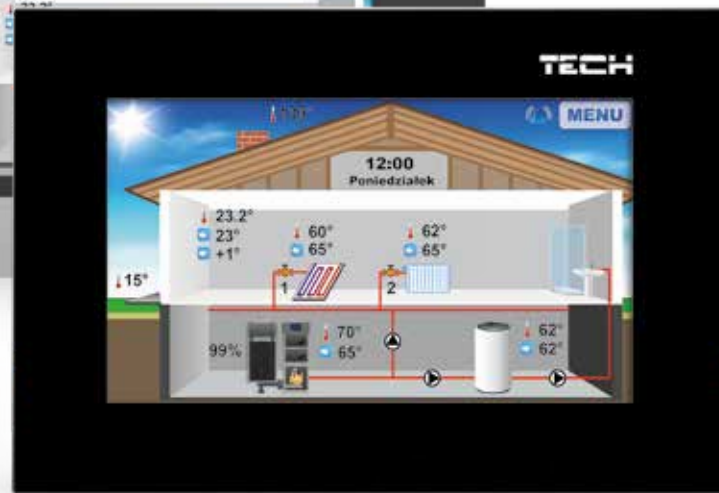

EU-281

Functions

- control of the room temperature
- control of the central heating boiler temperature
- control of the DHW temperature
- control of the mixing valves temperature
- outside temperature monitoring
- weekly-based heating mode
- alert
- parental lock
- displaying current room and CH boiler temperature
- possibility of updating software via USB port (from version 4.0)

Equipment EU-280 i EU-281

- large, clear, colour touch 4,3"-LCD display
- front panel made of 2mm glass (EU-281)
- built-in room sensor
- power supply 12V DC
- RS communication cable for the boiler controller
- USB port



Principle of operation

The room regulator allows convenient temperature control of the room, CH boiler, water tank and the mixing valves without the need to go to the boiler room. The regulator requires cooperation with TECH main controller with RS communication. A large clear colour touch screen makes it easy to read and change the controller parameters.

EU-2801 WiFi

ROOM REGULATOR WITH
OPENTHERM COMMUNICATION



**WIFI
COMMUNICATION**

Power	230 V
Wired communication	two-core cable
Temp. measurement accuracy	+/- 0,5 °C
Dimensions [mm]	127 x 90 x 20



Functions

- smart control of the room set temperature
- smart control of the CH boiler set temperature
- changing the room set temperature basing on the outside temperature (weather-based control)
- outside temperature view
- **WiFi communication**
- weekly-based heating program for room and boiler
- displaying alerts from heating device
- acces to temperature charts of heating device
- alert-clock
- parental lock

Equipment

- large, clear, colour-touchscreen
- built-in room sensor
- flush-mounted

Principle of operation

Use of room regulator provides intelligent control of the desired room temperature by automatically adjusting the proportional boiler temperature. Regulator can adjust the parameters of control algorithm. The device is compatible with OpenTherm/plu (OT+) and OpenTherm/lite (OT-) protocol. Large, clear, colour-touchscreen, allows convinient control and modulation of the regulator parameters. Easy installation on the wall, aesthetic look, touchscreen and reasonable price are another advantages of the controller.



eModul

CONTROL VIA MOBILE APP



EU-WiFi-OT

ROOM REGULATOR WITH
OPENTHERM COMMUNICATION



WIFI COMMUNICATION

Power	230 V
Wired communication	two-core cable
Temp. measurement accuracy	+/- 0,5 °C
Dimensions [mm]	105 x 135 x 28

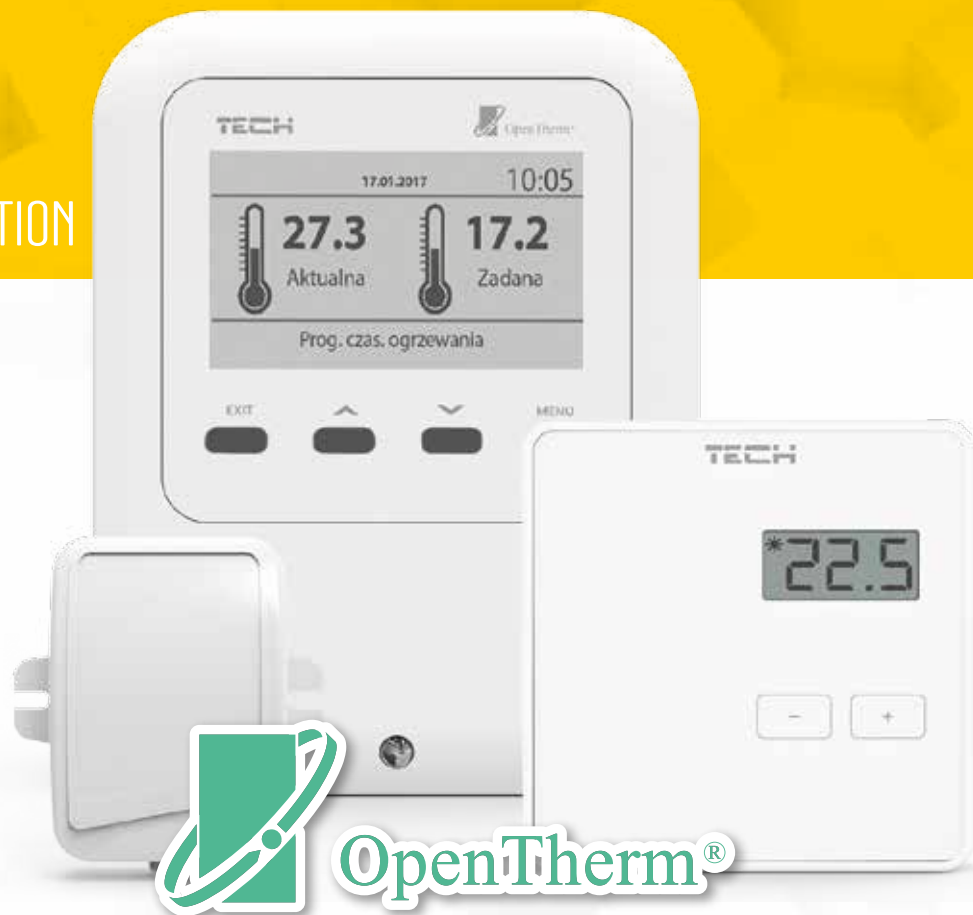

Funkcje

- smart control of the room set temperature
- smart control of the CH boiler set temperature
- changing the room set temperature basing on the outside temperature (weather-based control)
- acces to temperature charts of heating device
- outside temperature view
- weekly-based heating program for room and boiler
- displaying alerts from heating device
- **OpenTherm or two-state communication**
- **WiFi communication**

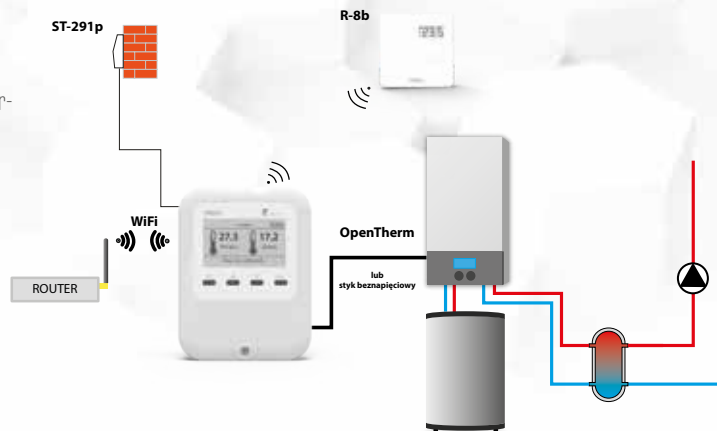

Equipment

- large display,
- wall mounted
- room regulator EU-R-8b in set
- wired outdoor temperature sensor EU-291p in set,

Principle of operation

Use of room regulator provides intelligent control of the desired room temperature by automatically adjusting the proportional boiler temperature. Regulator can adjust the parameters of control algorithm. The device is compatible with OpenTherm/plu (OT+) and OpenTherm/lite (OT-) protocol.



eModul

CONTROL VIA MOBILE APP



EU-505, WiFi RS

INTERNET MODULE



Power	5V DC
LAN plug	RJ 45
Controller plug	RJ 12
Dimensions EU-505 [mm]	120 x 80 x 31
Dimensions WiFi RS [mm]	105 x 135 x 28

**LAN CABLE
COMMUNICATION**



**WiFi
COMMUNICATION**



Functions available with the latest controller versions

- remote control via the Internet - emodul.pl
- possibility of monitoring all connected devices
- possibility of editing all parameters of the main controller (in the menu structure)
- possibility of viewing the temperature history
- possibility of viewing the event log (alerts and parameter changes)
- possibility of assigning any number of passwords (to access menu, events, statistics)
- possibility of editing the pre-set temperature via a room regulator
- possibility of controlling many modules via one user account
- e-mail notification in case of alerts
- optional Text message notification in case of alerts (subscription necessary)

Equipment

- power supply unit 9V DC
- RS Splitter
- RS communication cable for the boiler controller

eModul
CONTROL VIA MOBILE APP



Functions available with older controller versions

- remote control of the CH boiler operation via the Internet or a local network- zdalnie.techsterowniki.pl
- graphic interface offering animations on the home computer screen
- possibility of changing the pre-set temperature values for both the pumps and the mixing valves
- possibility of changing the pre-set temperatures via a room regulator with RS communication
- possibility of viewing the sensor temperatures
- possibility of viewing the history and the alert types
- mobile version available at Google Play

ZDALNIE



EU-517

2 HEATING CIRCUITS MODULE

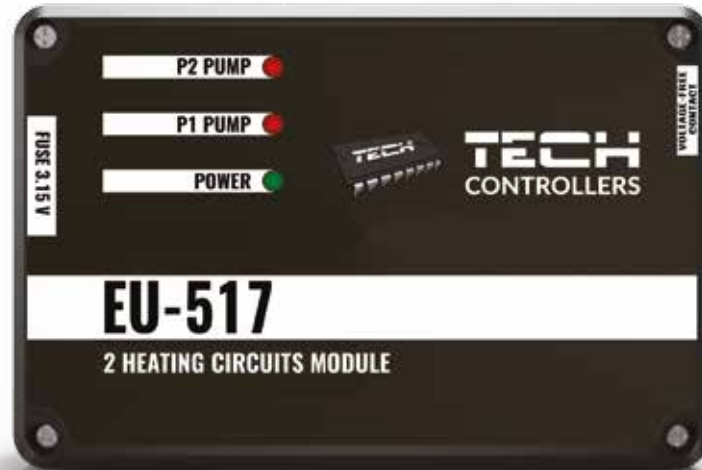

Function

- controlling of two pumps
- cooperation with two room regulators
- controlling of voltage free output

Principle of operation

The module may control two circulation pumps. When the room regulator sends a signal informing that the room temperature is too low, the module activates an appropriate pump. If the temperature of any circuit is too low, the module activates the voltage-free contact. If the module is used to control the floor heating system, an additional bimetallic sensor should be installed (on the supply pump, as close to the CH boiler as possible) -thermal overload relay. If the alarm temperature is exceeded, the sensor will disable the pump in order to protect the fragile floor heating system. If EU-517 is used to control standard heating system, the thermal overload relay may be replaced with a jumper -join the input terminals of the thermal overload relay. .

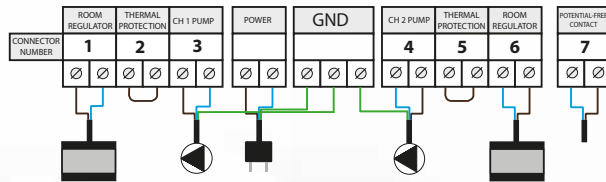

EU-401n PWM

SOLAR COLLECTOR CONTROLLER



Power	230V 50Hz
Pump output load EU-21 SOLAR	1 A
Pump output load EU-400	0,5 A
Additional outputs load	1 A
Pump/valve output load	1 A
Durability the solar temperature sensor	-40°C - 180°C
Dimensions [mm]	110 x 163 x 57

Functions EU-401n

- control of the pumps
- supervision and handling of the solar system operation
- protection against overheating and freezing of the collector
- the possibility of connecting EU-505 ETHERNET/EU-WIFI RS module
- the possibility of connecting additional device:
 - circulation pump
 - electric heater
 - sending a signal to the CH boiler to fire it up

Equipment

- large, clear LCD display
- collector temperature sensor
- heat accumulator temperature sensor
- casing made of high quality materials resistant to high and low temperatures

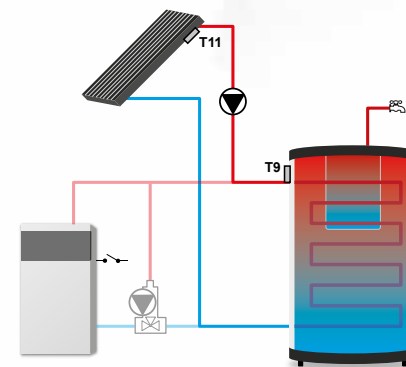

Principle of operation

Thermoregulators are intended for operation of solar collector systems. This device controls the main (collector) pump on the basis of temperature measurement on the collector and in the accumulation tank. There is an optional possibility of connecting additional devices such as a mixing pump or an electric heater as well as to send a signal to the CH boiler to fire it up. Control of the circulation pump and sending the firing-up signal to the CH boiler is possible directly from the controller and in the case of the heater control an additional signal relay is necessary

EU-402n PWM

SOLAR COLLECTOR CONTROLLER



Power	230V 50Hz
Pump output load	1 A
Additional outputs load	1 A
Pump/valve output load	1 A
Durability the solar temperature sensor	-40°C - 180°C
Dimensions [mm]	110 x 163 x 57

Functions

- control of the pump via PWM signal
- supervision and handling of the solar system operation for 17 configurations of the system
- protection against overheating and freezing of the collector
- the possibility of connecting EU-505 ETHERNET/EU-WIFI RS module
- the possibility of connecting additional device:
 - circulation pump
 - electric heater
 - sending a signal to the CH boiler to fire it up

Equipment

- **large, clear LCD display (EU-402n PMW)**
- collector temperature sensor
- heat accumulator temperature sensor
- casing made of high quality materials resistant to high and low temperatures

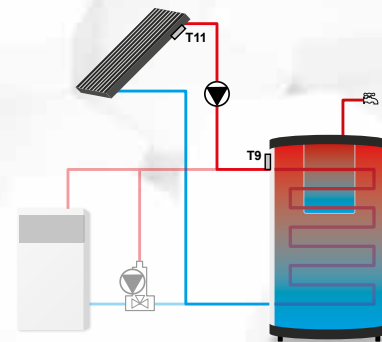

17 diagrams to choose from

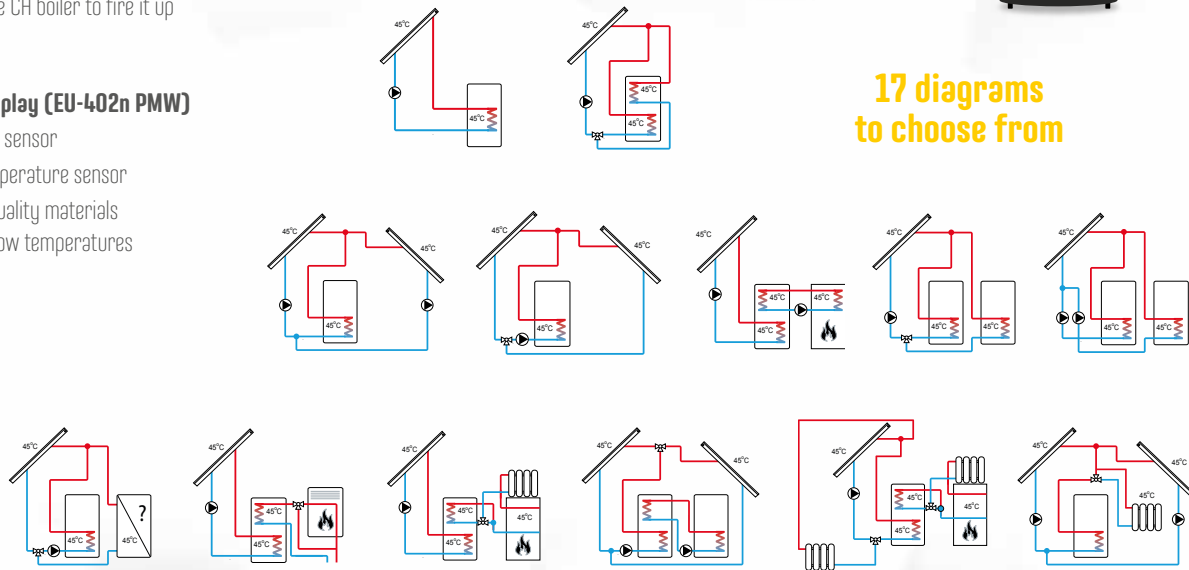

EU-STZ-120 T

MIXING VALVE ACTUATOR

Power	230V 50Hz
Max power consumption	1,5 W
The ambient operating temperature	5°C-50°C
Rotation time	120 s
Dimensions [mm]	75 x 80 x 105



Functions

- control of three-way or four-way valve
- manual control possible with pull-out knob
- rotation time: 120s

Equipment

- adapters and mounting screws for valves from companies such as ESBE, Afriso, Herz, Womix, Honeywell, Wita
- connection cable length: 1.5 m

Principle of operation

The STZ-120 T actuator is used to control three-way and four-way mixing valves. It is controlled by a 3-point signal.

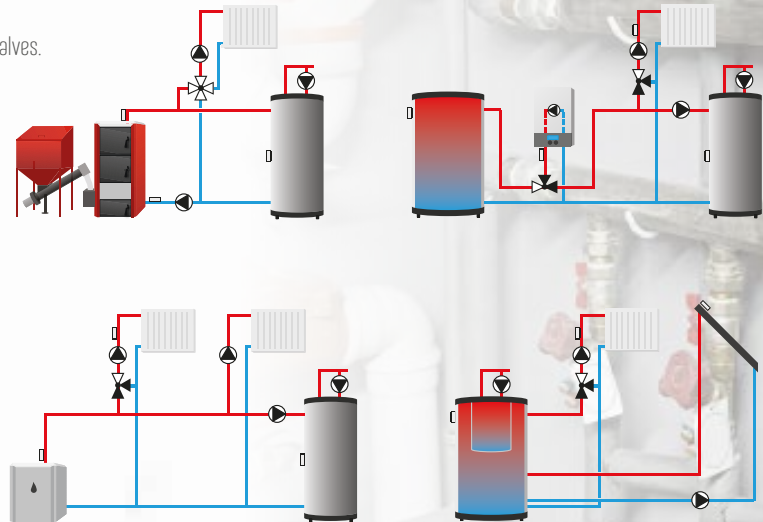

STZ-180 RS

MIXING VALVE ACTUATOR

Power	12V DC
Max power consumption	1,5 W
The ambient operating temperature	5°C-50°C
Rotation time	180 s
Dimensions [mm]	75 x 80 x 105



Functions

- Control of three-way or four-way valve
- Rotation time: 180s
- czas obrotu 180s
- Display of current temperature/valve opening percentage/set temperature
- Autonomous operation capability
- RS communication with main controller (EU-i-1, EU-i-2 PLUS, EU-i-3 PLUS, EU-L-7e, EU-L-8e, EU-L-9r, EU-L-4X WiFi, EU-L-X WiFi, EU-L-12)
- Built-in low-voltage contact for valve pump control

Equipment

- Adapters and mounting screws for valves from companies such as ESBE, Afriso, Herz, Womix, Honeywell, Wita
- Temperature sensor included
- 12V power supply included

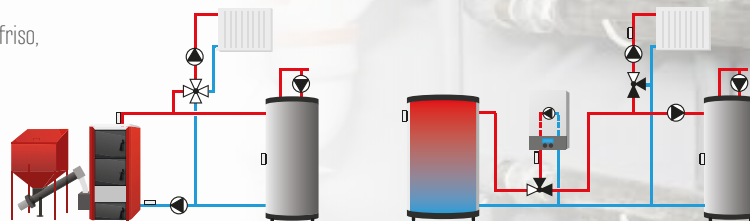

Principle of operation

The STZ-180 RS actuator is used to control three-way and four-way mixing valves.

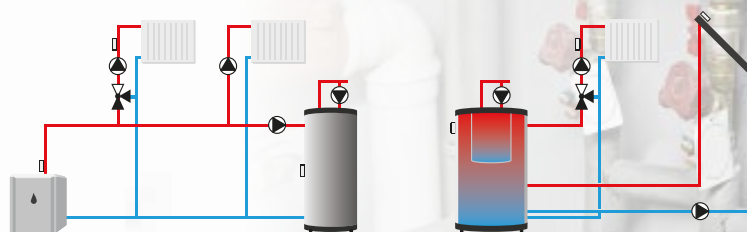

STI-400

INVERTER



Zasilanie	230V / 50Hz
Power	400 W
Ambient operating temperature	5°C-50°C
Input voltage	230V AC x1 - 12VDC s
Output voltage	230V AC
Dimensions [mm]	460 x 105 x 360

Principle of operation

An inverter is a controller that allows devices (typically boilers) to operate in the event of a mains power outage. It functions similarly to typical UPS systems, with the difference being that instead of cells, energy is stored in a battery. While the target device is connected to the inverter and powered by the mains, the battery is kept in standby. In the event of a mains power outage, the controller switches to inverter mode, meaning the energy stored in the battery is converted to 230V, and the device can continue to operate. The controller works with two types of batteries, gel and acid, for which separate standby algorithms are written.

TECH CONTROLLERS

ul. Biała Droga 31, 34-122 Wieprz

tel. +48 33 330 00 07, fax. +48 33 845 45 47

poczta@techsterowniki.pl, www.tech-controllers.com



Printed 02/2024